

Hand Shower Set Installation Manual

W-110(ES)

Warranty Duration

All components of this faucet system are covered under a lifetime limited warranty, ensuring they are free from defects in material and workmanship for the original purchaser.

Repair and Replacement

If the product shows defects in material or workmanship under normal use and within the warranty period, we will, at our discretion, either repair the product or provide a replacement at no cost to the original purchaser. Please note that proof of purchase (e.g., an invoice) is required when requesting service. The warranty does not cover damages caused by improper installation, misuse, or modifications.

Exclusions

We shall not be responsible for the following cases:

- Damage to the product caused by improper installation, misuse, unauthorized repair or replacement, or abuse (including damage during shipment).
- Damage to the product caused by improper dismantling after installation.
- Damage resulting from abnormal water pressure or impurities in water pipes, which is not covered under this warranty.
- Rust on the product due to insufficient care and maintenance, which is not covered under this warranty.
- Damage caused by natural disasters such as fire, flood, earthquake, lightning storms, etc., which is not covered under this warranty.

I hope this helps! If you have any further questions or concerns, please let me know.

Having Trouble? Contact us.

 Email: info@faucetsupport.com

 Toll Free: 1-888-969-6880



M8649
SFS-3071

CONTENT

1. Hand Shower Set Installation Manual ----- (1-3)

CONTENIDO

1. Manual de instalación del conjunto de teleducha ----- (4-6)

◆ Installation and Maintenance Matters

1. Check the accessories list to verify that all parts are complete in this package.
2. Do not disassemble the main body by yourself.
3. Connect inlet pipes to supply valves.
4. Make sure inlet pipes and supply valves have no impurities and are cleaned, with no impurities in the pipeline.
5. After installation, check all joints for leakages.
6. Do not leave the basin faucet exposed to a severely corrosive environment.

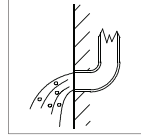

Do's

1. In order to keep the mixer surface bright, please clean the mixer regularly.
2. Rinse the faucet with clean water and wipe it with a soft cotton cloth.
3. Use one of the following cleaners to remove dirt from the surface: a. Mild liquid cleaner. b. Colorless glass cleaner and powder cleaner that do not cause abrasion and can be dissolved completely. c. Polish liquid that does not cause abrasion.

Don'ts

- a. Avoid using cleaning powder, harsh cleaning chemicals, brushes and coarse cloth to prevent scratching and friction.
- b. Do not use acid cleaners to clean the faucet as they may cause surface corrosion of the faucet. If the faucet is exposed to harmful acid substances, please rinse it immediately with water.

Tools Needed:

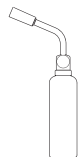
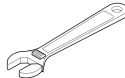
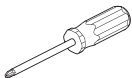

◆ Hand Shower Set
Accessories List

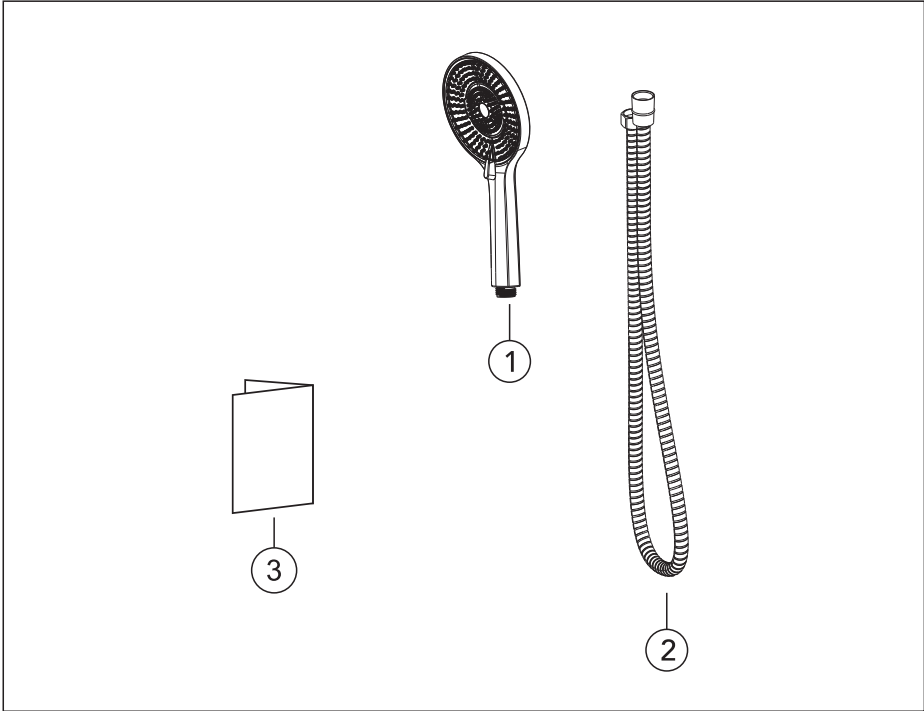

No.	Part name	Qty	No.	Part name	Qty
1	Hand shower	1	3	Instruction manual	1
2	Shower hose	1			

◆ Connecting the Shower Hose to the Handheld Shower

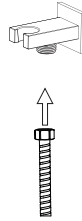
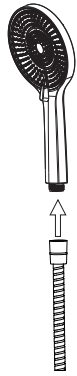

A shower holder or other outlet accessory can be connected here (outlet accessories not included in this package).

As shown in the figure, connect one end of the shower hose to the handheld shower and tighten. Connect the other end to the outlet accessory to complete the installation.

◆ Instalación y cuestiones de mantenimiento

1. Verifique la lista de accesorios para comprobar que todas las partes están completas en este paquete.
2. No desmonte el cuerpo principal por sí mismo.
3. Conecte las tuberías de entrada a las válvulas de suministro.
4. Asegúrese de que las tuberías de entrada y las válvulas de suministro no tengan impurezas y estén limpias, sin impurezas en la tubería.
5. Después de la instalación, verifique todas las uniones para detectar fugas.
6. No deje el sistema de ducha tipo lluvia expuesto a un ambiente severamente corrosivo.

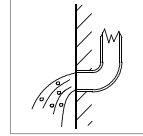

Hacer

1. En para mantener la superficie de la batidora brillante, limpie el mezclador regularmente.
2. Inse el grifo con agua limpia y límpielo con un suave ropa de algodón.
3. Utilice uno de los siguientes limpiadores para eliminar la suciedad de la superficie: a. Limpiador líquido suave. b. Limpiador de vidrio incoloro y limpiador en polvo que no causen abrasión y que se puedan disolver completamente. c. Líquido pulidor que no cause abrasión.

No es decir

- A. Valte con polvo de limpieza, productos químicos de limpieza duros, cepillos y tela gruesa para evitar rascar y fricción.
- B. No use limpiadores de ácidos para limpiar el grifo, ya que pueden causar corrosión superficial del grifo. Si el grifo está expuesto a sustancias ácidas dañinas, enjuague inmediatamente con agua.

Herramientas Necesarias:

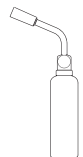
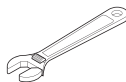
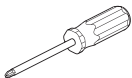

◆ **Conjunto de teleducha**
Lista de accesorios

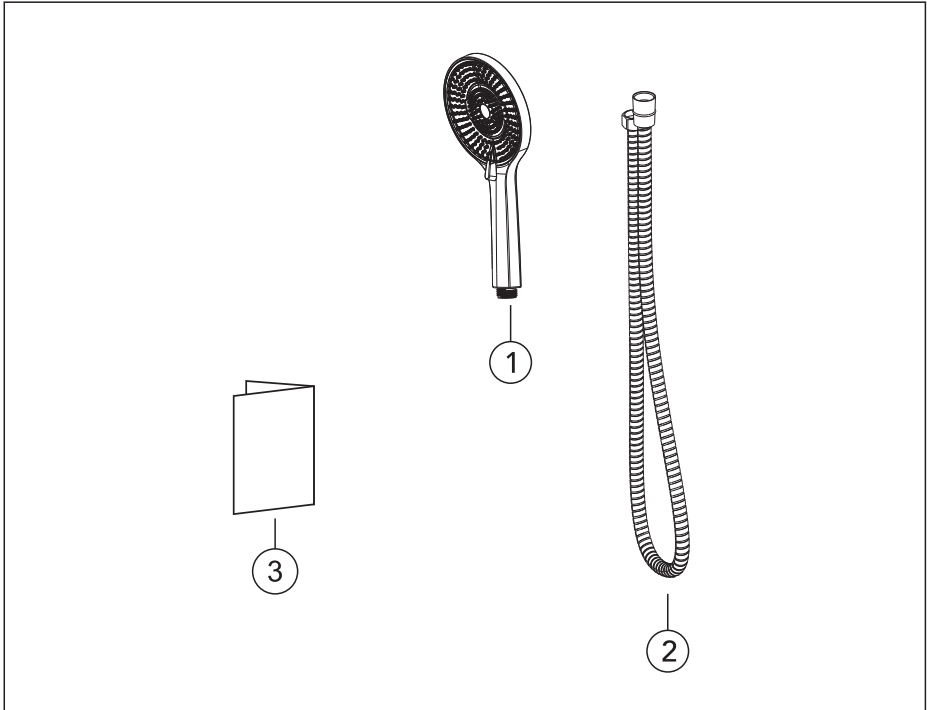

N.º	Nombre de la pieza	Cant	N.º	Nombre de la pieza	Cant
1	Ducha de mano	1	3	Manual de instrucciones	1
2	Manguera de ducha	1			

◆ Conexión de la manguera de ducha a la teleducha manual

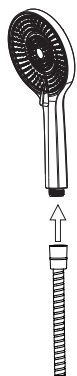

Aquí se puede conectar un soporte de ducha u otro accesorio de salida (los accesorios de salida no están incluidos en este paquete).



Tal como se muestra en la figura, conecte un extremo de la manguera de ducha a la teleducha manual y apriete firmemente. Conecte el otro extremo al accesorio de salida para completar la instalación.
