

# **Bathroom Accessories Set Installation Manual**

**W-274(ES)**

# Warranty Duration

All components of this faucet system are covered under a lifetime limited warranty, ensuring they are free from defects in material and workmanship for the original purchaser.

# Repair and Replacement

If the product shows defects in material or workmanship under normal use and within the warranty period, we will, at our discretion, either repair the product or provide a replacement at no cost to the original purchaser. Please note that proof of purchase (e.g., an invoice) is required when requesting service. The warranty does not cover damages caused by improper installation, misuse, or modifications.

# Exclusions

We shall not be responsible for the following cases:

- Damage to the product caused by improper installation, misuse, unauthorized repair or replacement, or abuse (including damage during shipment).
- Damage to the product caused by improper dismantling after installation.
- Damage resulting from abnormal water pressure or impurities in water pipes, which is not covered under this warranty.
- Rust on the product due to insufficient care and maintenance, which is not covered under this warranty.
- Damage caused by natural disasters such as fire, flood, earthquake, lightning storms, etc., which is not covered under this warranty.

I hope this helps! If you have any further questions or concerns, please let me know.

# Having Trouble? Contact us.

 Email: [info@faucetsupport.com](mailto:info@faucetsupport.com)

 Toll Free: 1-888-969-6880



**M8631**  
**SFS-2005**

## **CONTENT**

**Bathroom Accessories Set Installation Instructions ----- (1-2)**

## **CONTENIDO**

**Instrucciones de instalación del juego de accesorios de baño ----- (3-4)**

## ◆ Usage and Maintenance

- 1.Regularly check the tightness of the accessories to ensure they are secure and safe.
- 2.Clean using mild detergents, avoiding strong acidic or alkaline cleaning products.
- 3.Replace any damaged accessories promptly.

## ◆ Bathroom Accessories Parts List

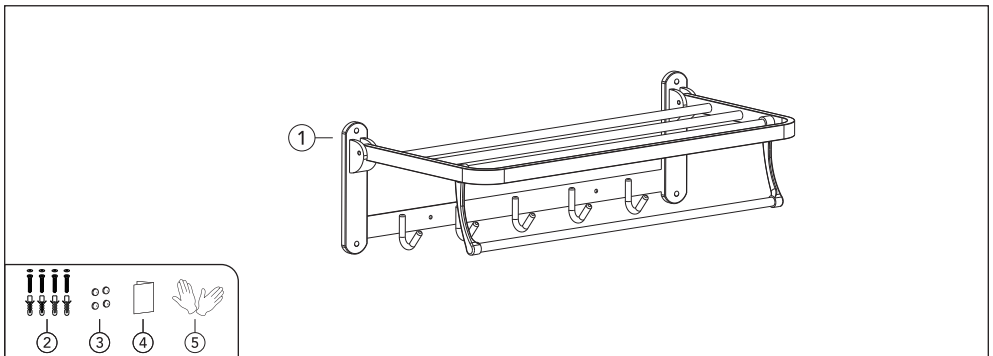

No.	Part name	Qty	No.	Part name	Qty
1	Accessory main body	1	4	Instruction manual	1
2	Accessory Screw Components	1set	5	Gloves	1 pair
3	Screw decorative cover	1set	6		

## ◆ Installation Steps

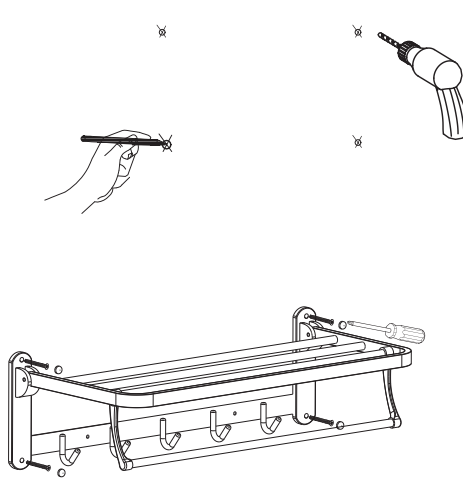

### 1. Determine Positions:

Mark the desired locations on the wall for each accessory.

### 2. Drill Holes and Install Wall Plugs:

Use an electric drill to create holes at the marked positions, then insert the wall plugs securely.

### 3. Install the main body:

Align the main body of the accessory with the screw holes and fasten the screws accordingly.

## ◆ Uso y mantenimiento

- 1.Revise regularmente el ajuste de los accesorios para asegurarse de que estén seguros y bien sujetos.
- 2.Limpie utilizando detergentes suaves, evitando productos de limpieza fuertemente ácidos o alcalinos.
- 3.Reemplace de inmediato cualquier accesorio dañado.

## ◆ Lista de piezas de accesorios de baño

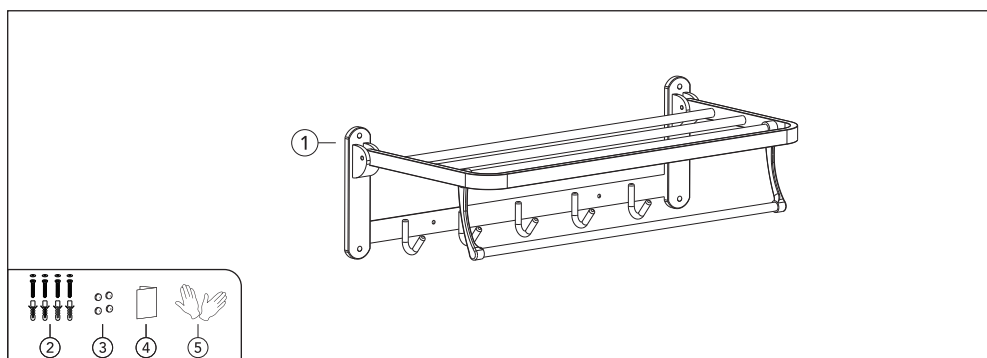

N.º	Nombre de la pieza	Cantidad	N.º	Nombre de la pieza	Cantidad
1	Cuerpo principal del accesorio	1	4	Manual de instrucciones	1
2	Componentes de tornillos del accesorio	1 juego	5	Guantes	1 par
3	Cubierta decorativa del tornillo	1 juego	6		

## ◆ Pasos de instalación

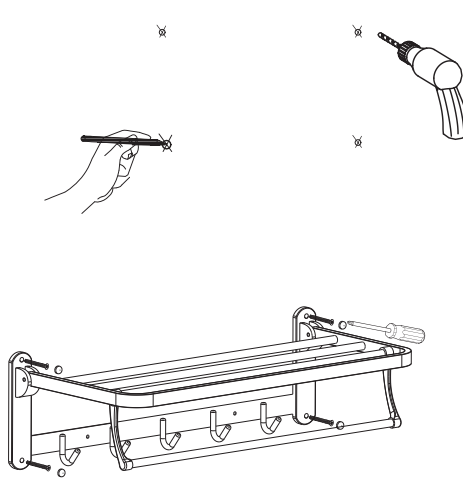

### 1. Determine las posiciones:

Marque los lugares deseados en la pared para cada accesorio.

### 2. Perfore agujeros e instale los tacos de pared:

Use un taladro eléctrico para hacer agujeros en las posiciones marcadas, luego inserte firmemente los tacos de pared.

### 3. Instale el cuerpo principal:

Alinee el cuerpo principal del accesorio con los orificios para tornillos y fíjelo adecuadamente.