

# **Universal Mounting Accessories Installation Manual**

**W-323(ES)**

# Warranty Duration

All components of this faucet system are covered under a lifetime limited warranty, ensuring they are free from defects in material and workmanship for the original purchaser.

# Repair and Replacement

If the product shows defects in material or workmanship under normal use and within the warranty period, we will, at our discretion, either repair the product or provide a replacement at no cost to the original purchaser. Please note that proof of purchase (e.g., an invoice) is required when requesting service. The warranty does not cover damages caused by improper installation, misuse, or modifications.

# Exclusions

We shall not be responsible for the following cases:

- Damage to the product caused by improper installation, misuse, unauthorized repair or replacement, or abuse (including damage during shipment).
- Damage to the product caused by improper dismantling after installation.
- Damage resulting from abnormal water pressure or impurities in water pipes, which is not covered under this warranty.
- Rust on the product due to insufficient care and maintenance, which is not covered under this warranty.
- Damage caused by natural disasters such as fire, flood, earthquake, lightning storms, etc., which is not covered under this warranty.

I hope this helps! If you have any further questions or concerns, please let me know.

# Having Trouble? Contact us.

 Email: [info@faucetsupport.com](mailto:info@faucetsupport.com)

 Toll Free: 1-888-969-6880

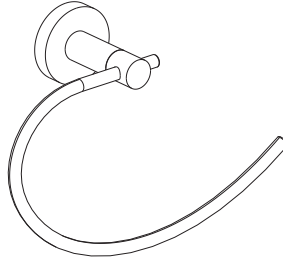

**M8654**  
**SFS-1333R**

**CONTENT**

**Universal Mounting Accessories Installation Manual** ----- (1-3)

**CONTENIDO**

**Manual de Instalación de Accesorios de Montaje Universales**  
----- (4-6)

## ◆ Installation and Maintenance Instructions

1. Check the accessories list to verify that all parts are complete in this package.
2. Do not disassemble the main body by yourself.
3. Connect inlet pipes to supply valves.
4. Make sure inlet pipes and supply valves have no impurities and are cleaned, with no impurities in the pipeline.
5. After installation, check all joints for leakages.
6. Do not leave the towel ring exposed to a severely corrosive

### Do's

1. In order to keep the mixer surface bright, please clean the mixer regularly.
2. Rinse the faucet with clean water and wipe it with a soft cotton cloth.
3. Use one of the following cleaners to remove dirt from the surface:
  - a. Mild liquid cleaner.
  - b. Colorless glass cleaner and powder cleaner that do not cause abrasion and can be dissolved completely.
  - c. Polish liquid that does not cause abrasion.

### Don'ts

1. Avoid using cleaning powder, harsh cleaning chemicals, brushes and coarse cloth to prevent scratching and friction.
2. Do not use acid cleaners to clean the faucet as they may cause surface corrosion of the faucet. If the faucet is exposed to harmful acid substances, please rinse it immediately with water.

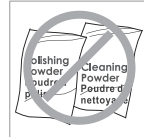
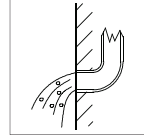

### Tools Needed:

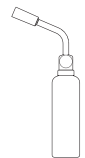
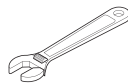
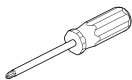

## ◆ Universal Mounting Accessories Accessories List

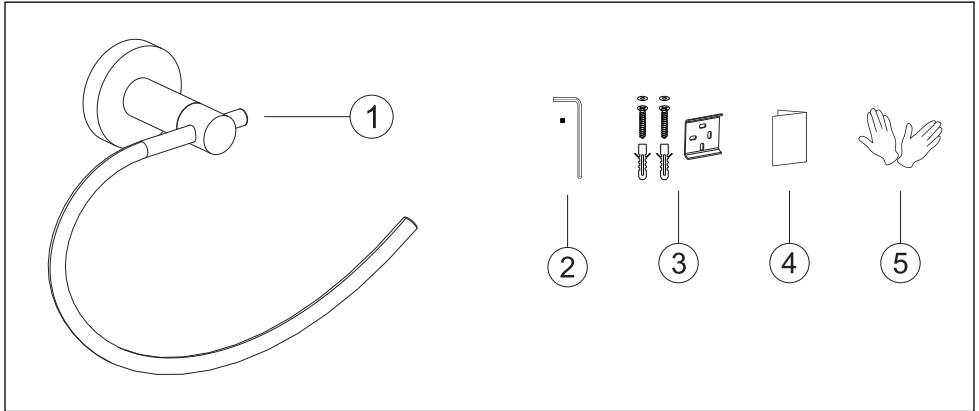

No.	Part Name	Qty	No.	Part Name	Qty
1	Universal Mounting Accessories	1	4	Instruction Manual	1
2	Componentes de tornillos para accesorios	1set	5	Gloves	2
3	Paquete de tornillos de fijación	1set			

## ◆ Installation Steps

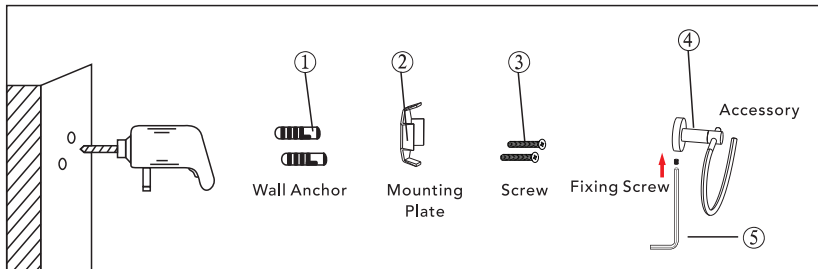

### 1. Determine Positions:

Mark the desired locations on the wall for each accessory.

### 2. Drill Holes and Install Wall Anchors:

Use an electric drill to create holes at the marked positions, then securely insert the wall anchors.

### 3. Secure the Mounting Plate:

Fix the mounting plate with screws, then slightly loosen the fixing screw (but do not remove it completely). Hang the accessory onto the mounting plate, ensuring the fixing screw is at the bottom.

## ◆ Installation of Universal Mounting Accessories

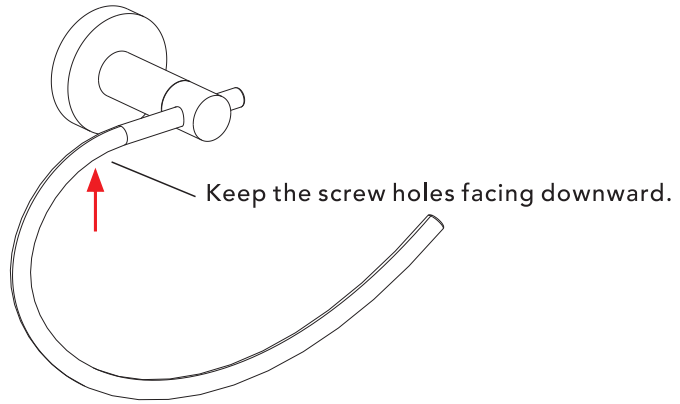

During installation, keep the screw holes facing downward and ensure the unit is oriented as shown in the diagram.

## ◆ Instalación y Cuestiones de Mantenimiento

1. Compruebe la lista de accesorios para verificar que todas las piezas están completas en este paquete.
2. No desmonte el cuerpo principal por su cuenta.
3. Conecte las tuberías de entrada a las válvulas de suministro.
4. Asegúrese de que las tuberías de entrada y las válvulas de suministro no tengan impurezas y estén limpias, y de que no haya impurezas en la tubería.
5. Después de la instalación, compruebe que todas las uniones no presenten fugas.
6. No deje el anillo para toallas expuesto a un entorno fuertemente corrosivo durante períodos prolongados.

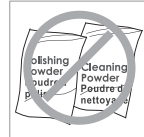
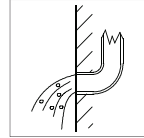

### Qué Sí Hacer

1. Para mantener brillante la superficie del grifo, límpielo regularmente.
2. Enjuague el grifo con agua limpia y séquelo con un paño de algodón suave.
3. Utilice uno de los siguientes limpiadores para eliminar la suciedad de la superficie:
  - a. Limpiador líquido suave.
  - b. Limpiador de vidrio incoloro y limpiador en polvo que no causen abrasión y se disuelvan completamente.
  - c. Líquido de pulido que no cause abrasión.

### Qué No Hacer

1. Evite el uso de polvos de limpieza, productos químicos de limpieza agresivos, cepillos y trapos ásperos para evitar arañazos y rozaduras.
2. No utilice limpiadores ácidos para limpiar el grifo, ya que pueden causar corrosión en la superficie. Si el grifo entra en contacto con sustancias ácidas dañinas, enjuáguelo inmediatamente con agua.

## Herramientas Necesarias:

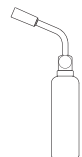
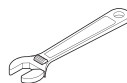
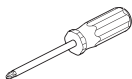

## ◆ Accesorios de Montaje Universales

### Lista de Accesorios

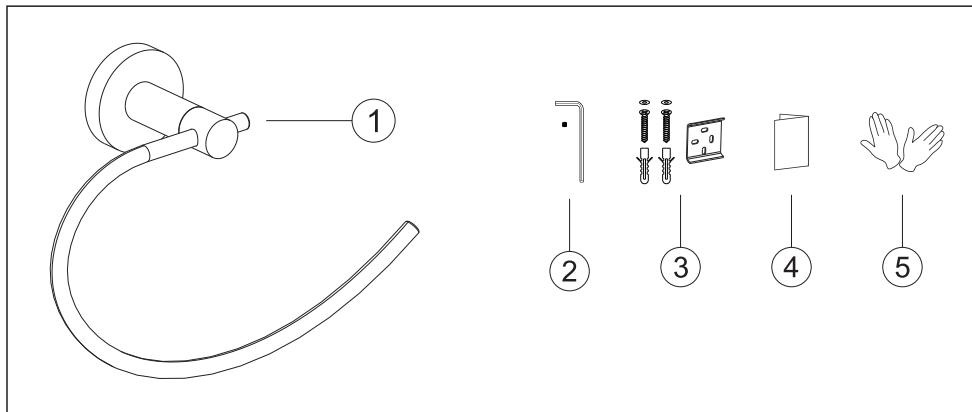

N.º	Nom de la pièce	Cantidad	N.º	Nom de la pièce	Cantidad
1	Accesorios de Montaje Universales	1	4	Manual de Instrucciones	1
2	Componentes de Tornillos para Accesorios	1set	5	Guantes	2
3	Paquete de Tornillos de Fijación	1set			

## ◆ Pasos de Instalación

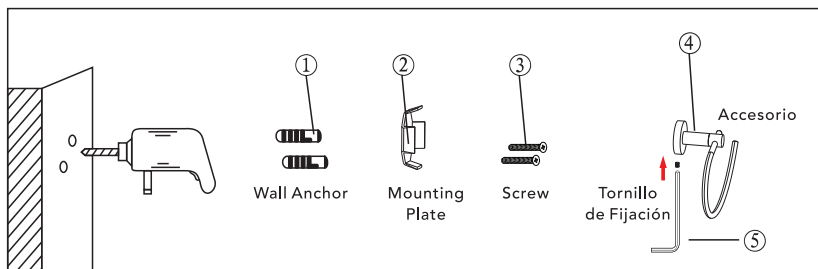

### 1. Determinar Posiciones:

Marque los lugares deseados en la pared para cada accesorio.

### 2. Perforar Agujeros e Instalar los Tacos de Pared:

Use un taladro eléctrico para crear agujeros en las posiciones marcadas, luego inserte los tacos de pared de manera segura.

### 3. Fijar las Placas de Montaje:

Asegure la placa de montaje con tornillos y afloje el tornillo de fijación (pero no lo quite completamente). Coloque el accesorio sobre la placa de montaje, asegurándose de que el tornillo de fijación esté en la parte inferior.

## ◆ Pasos de Instalación



Durante la instalación, mantenga los orificios de los tornillos hacia abajo y asegúrese de que la unidad esté orientada como se muestra en el diagrama.