

Basin Faucet Installation Manual

W-168(ES)

Warranty Duration

All components of this faucet system are covered under a lifetime limited warranty, ensuring they are free from defects in material and workmanship for the original purchaser.

Repair and Replacement

If the product shows defects in material or workmanship under normal use and within the warranty period, we will, at our discretion, either repair the product or provide a replacement at no cost to the original purchaser. Please note that proof of purchase (e.g., an invoice) is required when requesting service. The warranty does not cover damages caused by improper installation, misuse, or modifications.

Exclusions

We shall not be responsible for the following cases:

- Damage to the product caused by improper installation, misuse, unauthorized repair or replacement, or abuse (including damage during shipment).
- Damage to the product caused by improper dismantling after installation.
- Damage resulting from abnormal water pressure or impurities in water pipes, which is not covered under this warranty.
- Rust on the product due to insufficient care and maintenance, which is not covered under this warranty.
- Damage caused by natural disasters such as fire, flood, earthquake, lightning storms, etc., which is not covered under this warranty.

I hope this helps! If you have any further questions or concerns, please let me know.

Having Trouble? Contact us.

 Email: info@faucetsupport.com

 Toll Free: 1-888-969-6880



M2261-H
SFS-1314B

CONTENT

Basin Faucet Installation Manual ----- (1-5)

CONTENIDO

Manual de instalación del grifo para lavabo ----- (6-10)

◆ Installation and Maintenance Matters

1. Check the accessories list to ensure all parts are included.
2. Do not disassemble the main body by yourself.
3. Connect inlet pipes to supply valves.
4. Make sure inlet pipes and supply valves have no impurities and are cleaned, with no impurities in the pipeline.
5. After installation, check all joints for leakages.
6. Do not leave the basin faucet exposed to a severely corrosive environment.

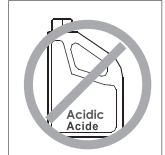
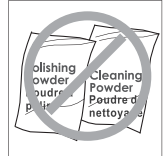
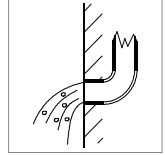

Do's

1. In order to keep the mixer surface bright, please clean the mixer regularly.
2. Rinse the faucet with clean water and wipe it with a soft cotton cloth.
3. Use one of the following cleaners to remove dirt from the surface: a. Mild liquid cleaner. b. Colorless glass cleaner and powder cleaner that do not cause abrasion and can be dissolved completely. c. Polish liquid that does not cause abrasion.

Don'ts

1. Avoid using cleaning powder, harsh cleaning chemicals, brushes and coarse cloth to prevent scratching and friction.
2. Do not use acid cleaners to clean the faucet as they may cause surface corrosion of the faucet. If the faucet is exposed to harmful acid substances, please rinse it immediately with water.

Tools Needed:

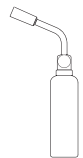
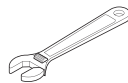
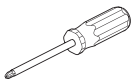

◆ **Basin Faucet Standard Part List**
Accessories List

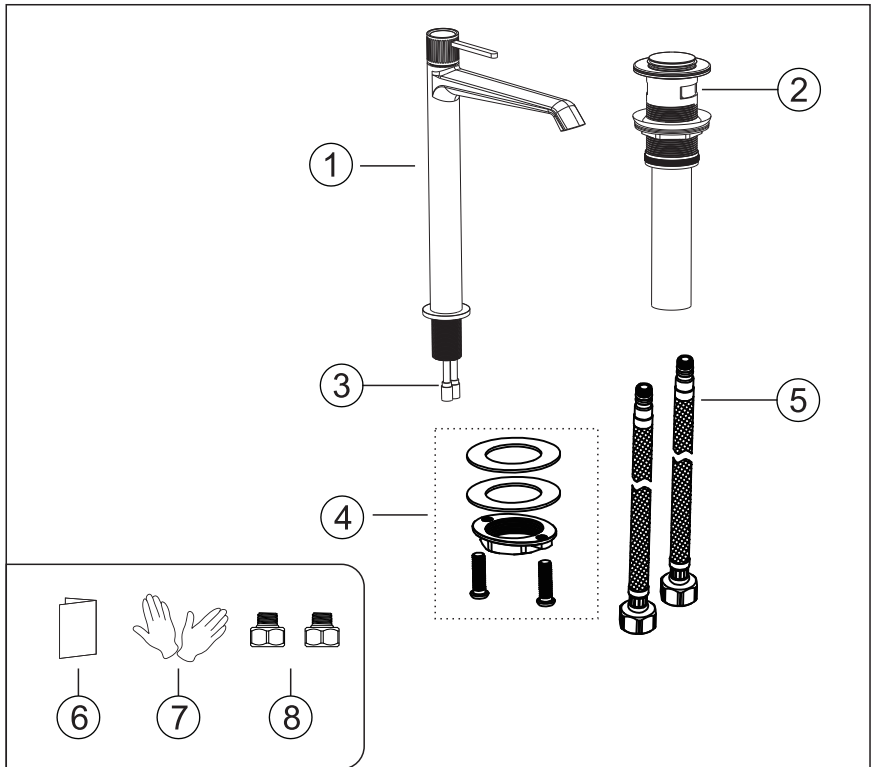

NO.	Part Name	Qty
1	Faucet Body	1
2	Pop-up Drain	1
3	Extension Copper Pipe	2
4	Tailpiece Nut Assembly	1 set
5	Hot and Cold Inlet Pipes	1 pair
6	Installation Manual	1
7	Gloves	2
8	Hose Adapter Change G9/16 to G1/2	1

◆ Faucet Installation Steps

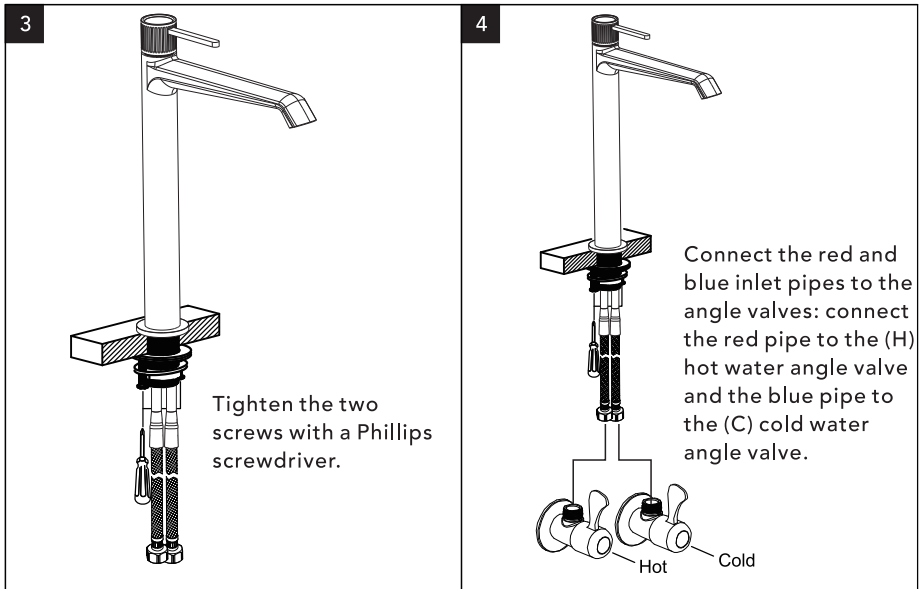
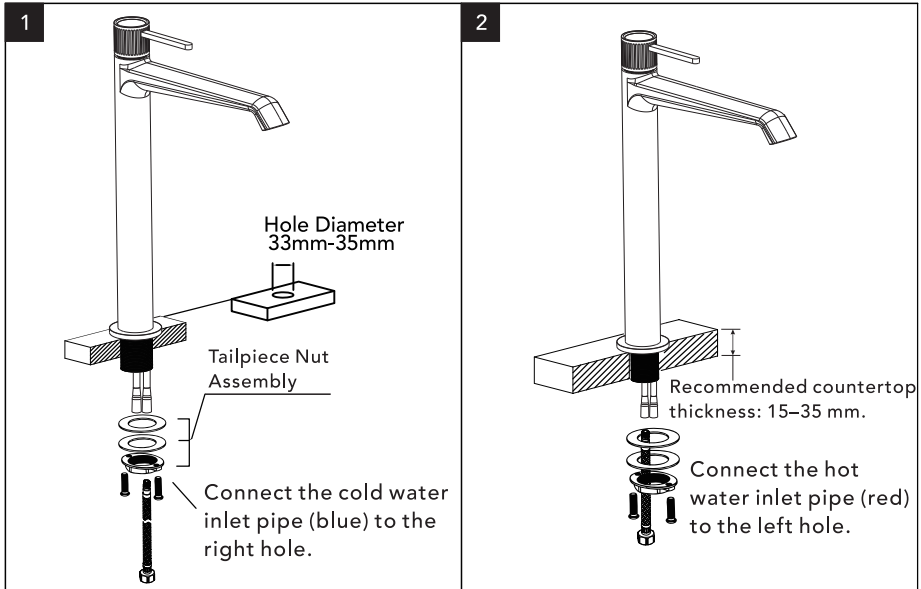

◆ Drain Installation

Step1

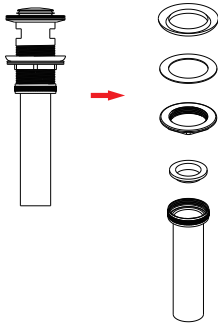

- Disassemble the drain starting from the bottom part. As shown in the left image, remove all components.

Step2

- Insert the top of the drain into the basin drain hole, and from the bottom upwards, sequentially fit the rubber gasket, washer, and fixing brass sleeve. Rotate the brass sleeve to the right until it is tight, but do not over-tighten to avoid damaging the basin or the drain.
- Finally, continue to rotate and tighten the lower part of the drain components downward to complete the drain installation.

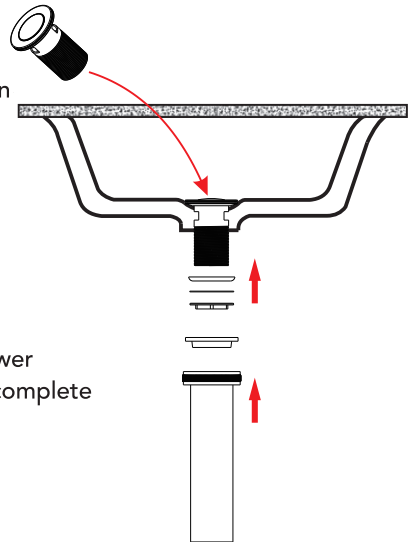

◆ Drain Installation

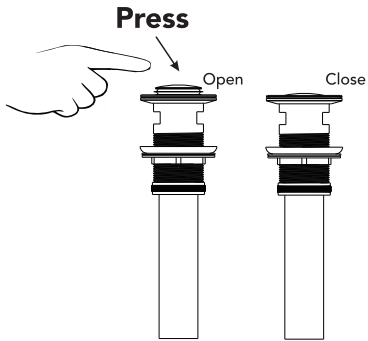

Press the pop-up button on top of the drain to open and close the drain outlet.



Notice:

1. **Sealing Test:** Turn on the faucet and let the water run for a few minutes. Observe the drain and the drainage pipe connections for any leaks. If you find any leaks, readjust the tightness of the gasket and nuts.
2. **Drainage Speed Test:** Ensure that the water drains smoothly without any blockages or slow drainage issues.
3. **Choose the Right Drain:** Different basins may require different sizes and types of drains. Make sure the drain you purchase matches your basin.

◆ Instalación y cuestiones de mantenimiento

1. Verifique la lista de accesorios para asegurarse de que todas las piezas estén incluidas.
2. No desmonte el cuerpo principal por sí mismo.
3. Conecte las tuberías de entrada a las válvulas de suministro.
4. Asegúrese de que las tuberías de entrada y las válvulas de suministro no tengan impurezas y estén limpias, sin impurezas en la tubería.
5. Después de la instalación, verifique todas las uniones para detectar fugas.
6. No deje el grifo para lavabo expuesto a un entorno altamente corrosivo.

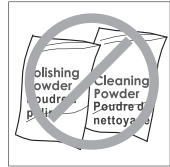
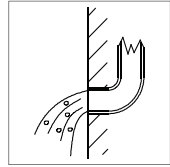

Hacer

1. En para mantener la superficie de la batidora brillante, limpie el mezclador regularmente.
2. Inse el grifo con agua limpia y límpielo con un suave ropa de algodón.
3. Utilice uno de los siguientes limpiadores para eliminar la suciedad de la superficie: a. Limpiador líquido suave. b. Limpiador de vidrio incoloro y limpiador en polvo que no causen abrasión y que se puedan disolver completamente. c. Líquido pulidor que no cause abrasión.

No es decir

1. Valte con polvo de limpieza, productos químicos de limpieza duros, cepillos y tela gruesa para evitar rascar y fricción.
2. No use limpiadores de ácidos para limpiar el grifo, ya que pueden causar corrosión superficial del grifo. Si el grifo está expuesto a sustancias ácidas dañinas, enjuague inmediatamente con agua.

HERRAMIENTAS NECESARIAS:

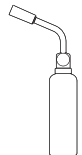
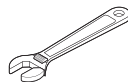
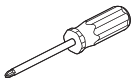

◆ Lista Estándar de Piezas del Grifo para Lavabo

Lista de Accesorios

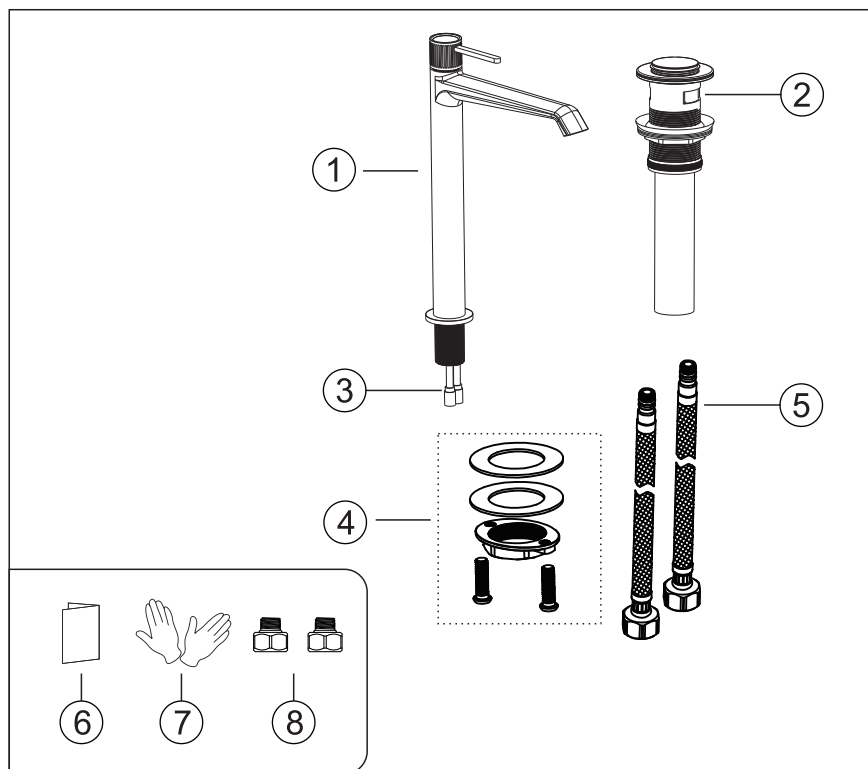

N.º	Nombre de la pieza	Cant.
1	Cuerpo del grifo	1
2	Desagüe con mecanismo de elevación	1
3	Tubo de extensión de cobre	2
4	Ensamblaje de la tuerca del manguito	1 juego
5	Tuberías de entrada de agua caliente y fría	1 par
6	Manual de instalación	1
7	Guantes	2
8	Adaptador de G9/16 a NPT1/2	2

◆ Pasos de instalación del grifo

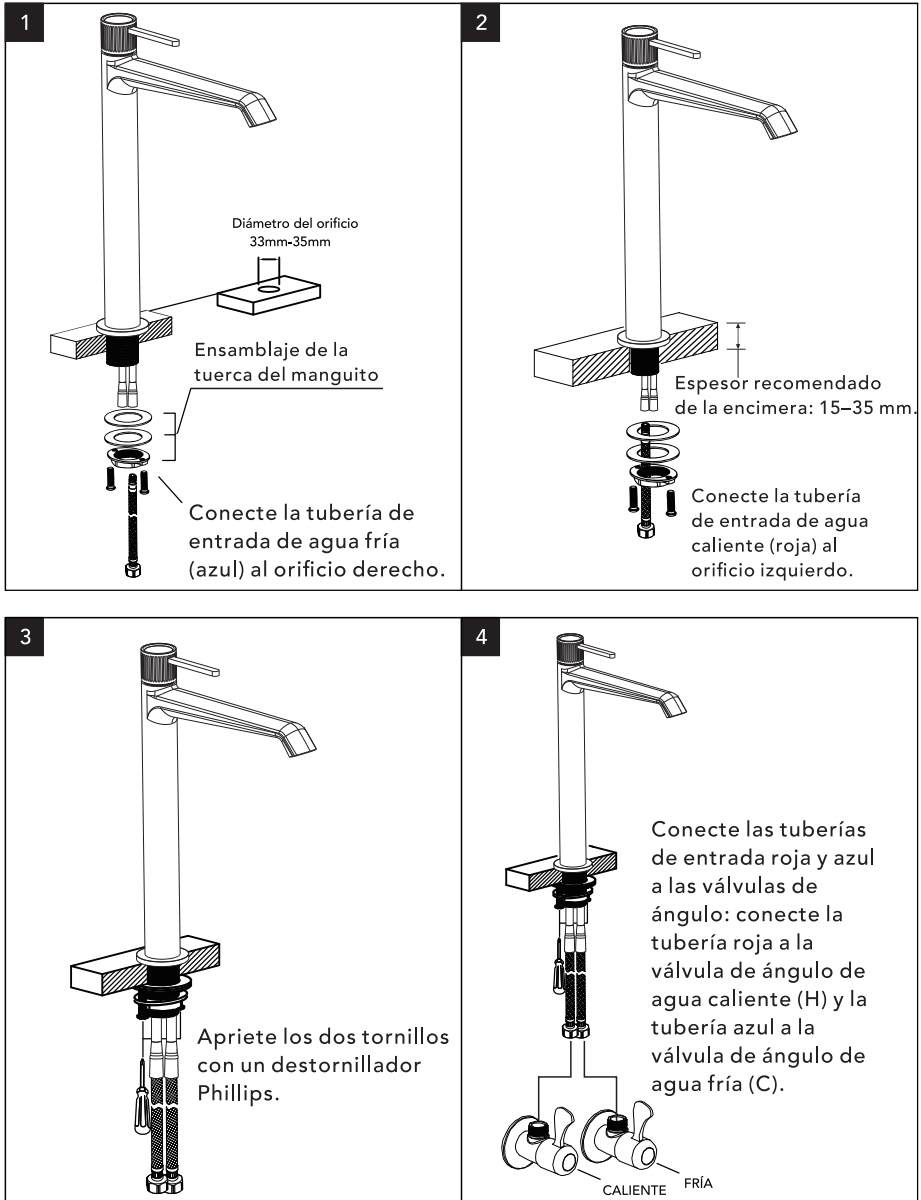

◆ Instalación del desagüe

Paso 1

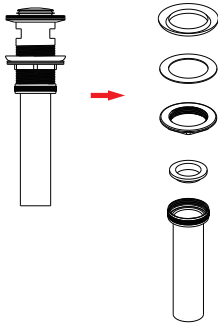

- Desmonte el desagüe comenzando por la parte inferior. Como se muestra en la imagen de la izquierda, retire todos los componentes.

Paso 2

- Inserte la parte superior del desagüe en el orificio de drenaje del lavabo y, desde la parte inferior hacia arriba, coloque secuencialmente la junta de goma, la arandela y la manga de fijación de latón. Gire la manga de latón hacia la derecha hasta que quede ajustada, pero no apriete en exceso para evitar dañar el lavabo o el desagüe.
- Finalmente, continúe girando y apretando hacia abajo la parte inferior de los componentes del desagüe para completar la instalación.

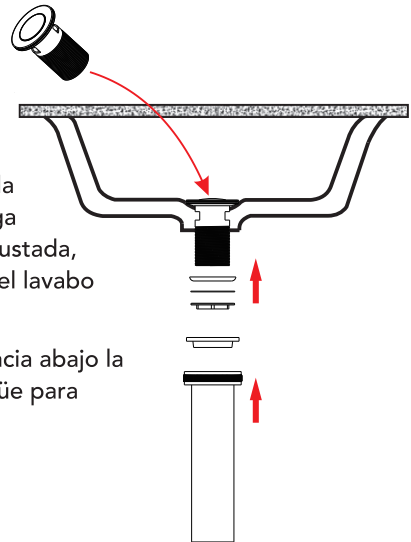

◆ Instalación del desagüe

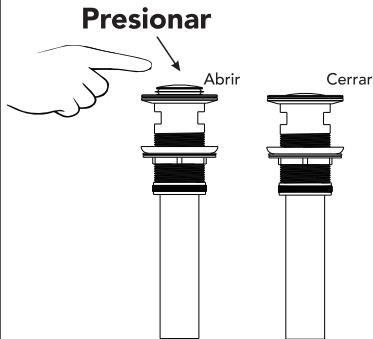

Presione el botón emergente en la parte superior del desagüe para abrir y cerrar la salida de agua.



Aviso:

1. Prueba de sellado: Abra el grifo y deje correr el agua durante unos minutos. Observe el desagüe y las conexiones de la tubería de drenaje para detectar posibles fugas. Si encuentra alguna fuga, reajuste la junta y las tuercas hasta lograr un sellado adecuado.
2. Prueba de velocidad de drenaje: Asegúrese de que el agua drene sin problemas, sin bloqueos ni problemas de drenaje lento.
3. Elija el desagüe adecuado: Diferentes lavabos pueden requerir distintos tamaños y tipos de desagües. Asegúrese de que el desagüe que compre sea compatible con su lavabo.