

Kitchen Faucet Installation Manual

W-329(ES)

Warranty Duration

All components of this faucet system are covered under a lifetime limited warranty, ensuring they are free from defects in material and workmanship for the original purchaser.

Repair and Replacement

If the product shows defects in material or workmanship under normal use and within the warranty period, we will, at our discretion, either repair the product or provide a replacement at no cost to the original purchaser. Please note that proof of purchase (e.g., an invoice) is required when requesting service. The warranty does not cover damages caused by improper installation, misuse, or modifications.

Exclusions

We shall not be responsible for the following cases:

- Damage to the product caused by improper installation, misuse, unauthorized repair or replacement, or abuse (including damage during shipment).
- Damage to the product caused by improper dismantling after installation.
- Damage resulting from abnormal water pressure or impurities in water pipes, which is not covered under this warranty.
- Rust on the product due to insufficient care and maintenance, which is not covered under this warranty.
- Damage caused by natural disasters such as fire, flood, earthquake, lightning storms, etc., which is not covered under this warranty.

I hope this helps! If you have any further questions or concerns, please let me know.

Having Trouble? Contact us.

 Email: info@faucetsupport.com

 Toll Free: 1-888-969-6880



M3205P
SFS-1302K

CONTENT

Kitchen Faucet Installation Manual ----- (1-3)

CONTENIDO

Manual de instalación del grifo de cocina ----- (4-6)

◆ Installation and Maintenance Matters

1. Check the accessories list to ensure all parts are included.
2. Do not disassemble the main body by yourself.
3. Connect inlet pipes to supply valves.
4. Make sure inlet pipes and supply valves have no impurities and are cleaned, with no impurities in the pipeline.
5. After installation, check all joints for leakages.
6. Do not leave the kitchen faucet exposed to a severely corrosive environment.

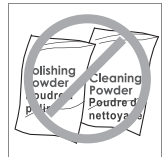
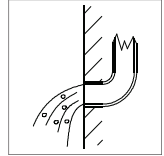

Do's

1. In order to keep the mixer surface bright, please clean the mixer regularly.
2. Rinse the faucet with clean water and wipe it with a soft cotton cloth.
3. Use one of the following cleaners to remove dirt from the surface: a. Mild liquid cleaner. b. Colorless glass cleaner and powder cleaner that do not cause abrasion and can be dissolved completely. c. Polish liquid that does not cause abrasion.

Don'ts

1. Avoid using cleaning powder, harsh cleaning chemicals, brushes and coarse cloth to prevent scratching and friction.
2. Do not use acid cleaners to clean the faucet as they may cause surface corrosion of the faucet. If the faucet is exposed to harmful acid substances, please rinse it immediately with water.

Tools Needed:

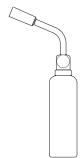
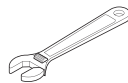
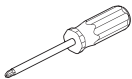

◆ **Hot and Cold Kitchen Faucet Accessories List**

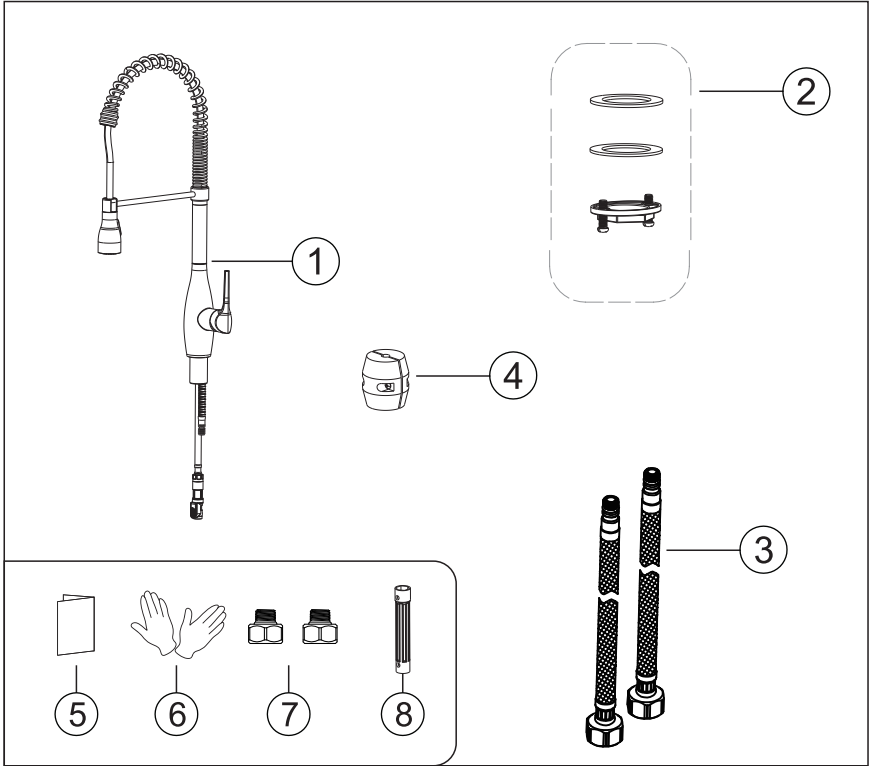

NO.	Part Name	Qty
1	Faucet Body	1
2	Tailpiece Nut Assembly	1 set
3	Hot and Cold Inlet Pipes	1 pair
4	Counterweight	1
5	Installation Manual	1
6	Gloves	1 pair
7	Hose Adapter Change G9/16 to G1/2	2
8	Socket Wrench	1

◆ Installation Step

1

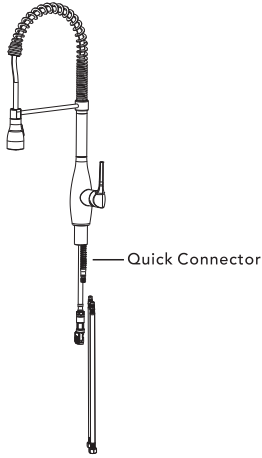

1. Align the hot and cold inlet hoses with the hot and cold ports under the faucet body. Screw them in clockwise until fully tightened.

2

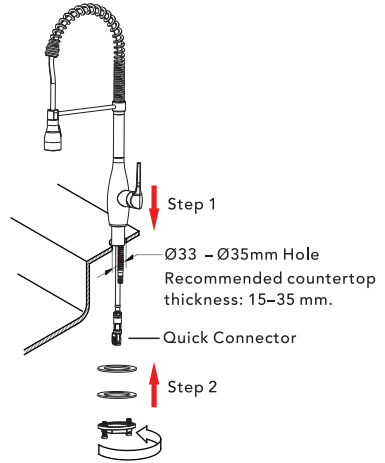

Step 1: Align the faucet body with the hole and insert it through the hole from the top down to install it onto the countertop.

Step 2: Screw the tailpiece nut assembly upward onto the external threads from below, then tighten it with a screwdriver.

3

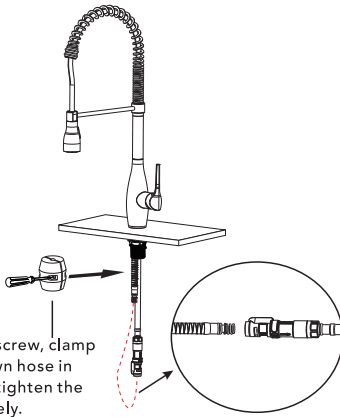

Loosen the screw, clamp the pull-down hose in place, then tighten the screw securely.

3. Connect the pull-down hose to the Quick Connector, as shown.

4

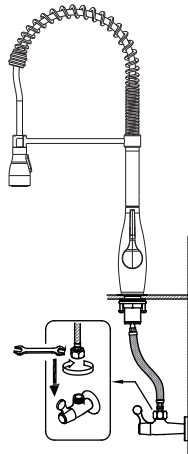

4. Connect hot and cold inlet hoses to the angle stops. Tighten with a wrench until snug. Turn on hot and cold angle stops and check for leaks.

◆ Instalación y cuestiones de mantenimiento

1. Verifique la lista de accesorios para asegurarse de que todas las piezas estén incluidas.
2. No desmonte el cuerpo principal por sí mismo.
3. Conecte las tuberías de entrada a las válvulas de suministro.
4. Asegúrese de que las tuberías de entrada y las válvulas de suministro no tengan impurezas y estén limpias, sin impurezas en la tubería.
5. Después de la instalación, verifique todas las uniones para detectar fugas.
6. No deje el grifo para lavabo expuesto a un entorno altamente corrosivo.

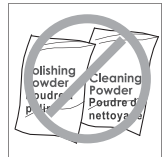
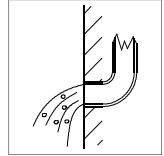

Hacer

1. En para mantener la superficie de la batidora brillante, limpie el mezclador regularmente.
2. Inse el grifo con agua limpia y límpielo con un suave ropa de algodón.
3. Utilice uno de los siguientes limpiadores para eliminar la suciedad de la superficie: a. Limpiador líquido suave. b. Limpiador de vidrio incoloro y limpiador en polvo que no causen abrasión y que se puedan disolver completamente. c. Líquido pulidor que no cause abrasión.

No es decir

1. Valte con polvo de limpieza, productos químicos de limpieza duros, cepillos y tela gruesa para evitar rascar y fricción.
2. No use limpiadores de ácidos para limpiar el grifo, ya que pueden causar corrosión superficial del grifo. Si el grifo está expuesto a sustancias ácidas dañinas, enjuague inmediatamente con agua.

HERRAMIENTAS NECESARIAS:

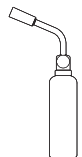
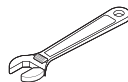
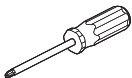

◆ **Grifo de cocina de agua caliente y fría**
Lista de accesorios

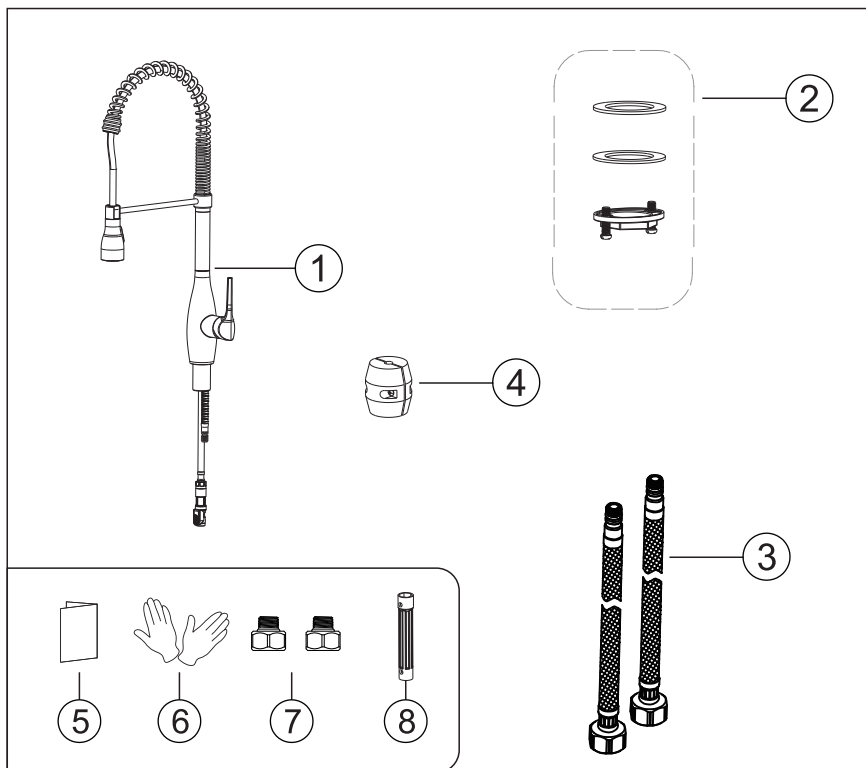

N.º	Nombre de la pieza	Cant.
1	Cuerpo del grifo	1
2	Arandela	2
3	Mangueras de entrada de agua caliente y fría	1 par
4	Contrapeso	1
5	Manual de instalación	1
6	Guantes	1 par
7	Adaptador de manguera (G9/16 a G1/2)	2
8	Llave de tubo	1

◆ Pasos de instalación

1

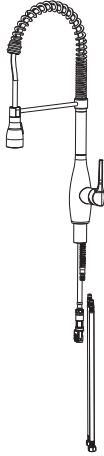

1. Alinee las mangueras de entrada de agua caliente y fría con las tomas de agua caliente y fría debajo del cuerpo del grifo. Enrósquelas en sentido horario hasta que queden completamente apretadas.

2

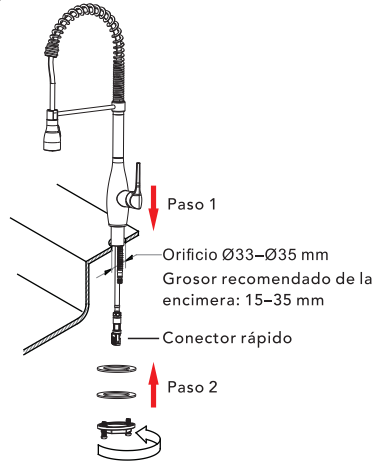

Paso 1: Alinee el cuerpo del grifo con el orificio e introdúzcalo desde la parte superior hacia abajo para instalarlo en la encimera.
Paso 2: Desde abajo, enrosque hacia arriba el conjunto de la tuerca del vástago (tailpiece) en las roscas externas y, luego, apriételo con un destornillador.

3

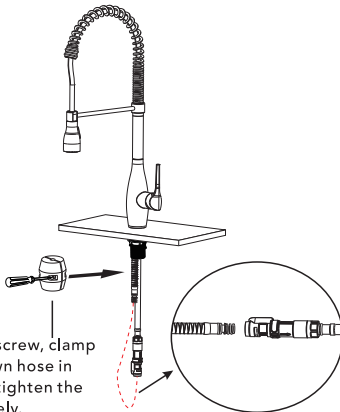

Loosen the screw, clamp the pull-down hose in place, then tighten the screw securely.

3. Conecte la manguera extraíble al conector rápido, como se muestra.

4

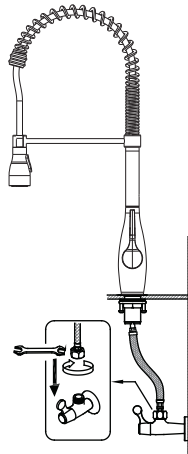

4. Conecte las mangueras de entrada de agua caliente y fría a las llaves de escuadra. Apriete con una llave hasta que queden firmes. Abra las llaves de escuadra de agua caliente y fría y compruebe que no haya fugas.