

Bidet Spray Gun Set Installation Manual

W-92(ES)

Warranty Duration

All components of this faucet system are covered under a lifetime limited warranty, ensuring they are free from defects in material and workmanship for the original purchaser.

Repair and Replacement

If the product shows defects in material or workmanship under normal use and within the warranty period, we will, at our discretion, either repair the product or provide a replacement at no cost to the original purchaser. Please note that proof of purchase (e.g., an invoice) is required when requesting service. The warranty does not cover damages caused by improper installation, misuse, or modifications.

Exclusions

We shall not be responsible for the following cases:

- Damage to the product caused by improper installation, misuse, unauthorized repair or replacement, or abuse (including damage during shipment).
- Damage to the product caused by improper dismantling after installation.
- Damage resulting from abnormal water pressure or impurities in water pipes, which is not covered under this warranty.
- Rust on the product due to insufficient care and maintenance, which is not covered under this warranty.
- Damage caused by natural disasters such as fire, flood, earthquake, lightning storms, etc., which is not covered under this warranty.

I hope this helps! If you have any further questions or concerns, please let me know.

Having Trouble? Contact us.

 Email: info@faucetsupport.com

 Toll Free: 1-888-969-6880



YL8118+8134-ES
SFS-1171
Model:A

CONTENT

1. Bidet Spray Installation Instructions ----- (1-4)

CONTENIDO

1. Instrucciones de instalación del rociador de bidé ----- (5-8)

◆ Installation and Maintenance Matters

1. Check the accessories list to verify that all parts are complete in this package.
2. Do not disassemble the main body by yourself.
3. Connect inlet pipes to supply valves.
4. Make sure inlet pipes and supply valves have no impurities and are cleaned, with no impurities in the pipeline.
5. After installation, check all joints for leakages.
6. Do not leave the rain shower system exposed to a severely corrosive environment.

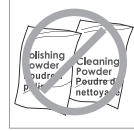
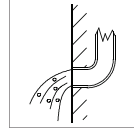

Do's

1. In order to keep the mixer surface bright, please clean the mixer regularly.
2. Rinse the faucet with clean water and wipe it with a soft cotton cloth.
3. Use one of the following cleaners to remove dirt from the surface: a. Mild liquid cleaner. b. Colorless glass cleaner and powder cleaner that do not cause abrasion and can be dissolved completely. c. Polish liquid that does not cause abrasion.

Don'ts

- a. Avoid using cleaning powder, harsh cleaning chemicals, brushes and coarse cloth to prevent scratching and friction.
- b. Do not use acid cleaners to clean the faucet as they may cause surface corrosion of the faucet. If the faucet is exposed to harmful acid substances, please rinse it immediately with water.

Tools Needed:

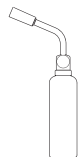
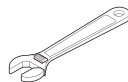
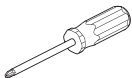

◆ Bidet Spray Main Body
Model:A
Accessories List

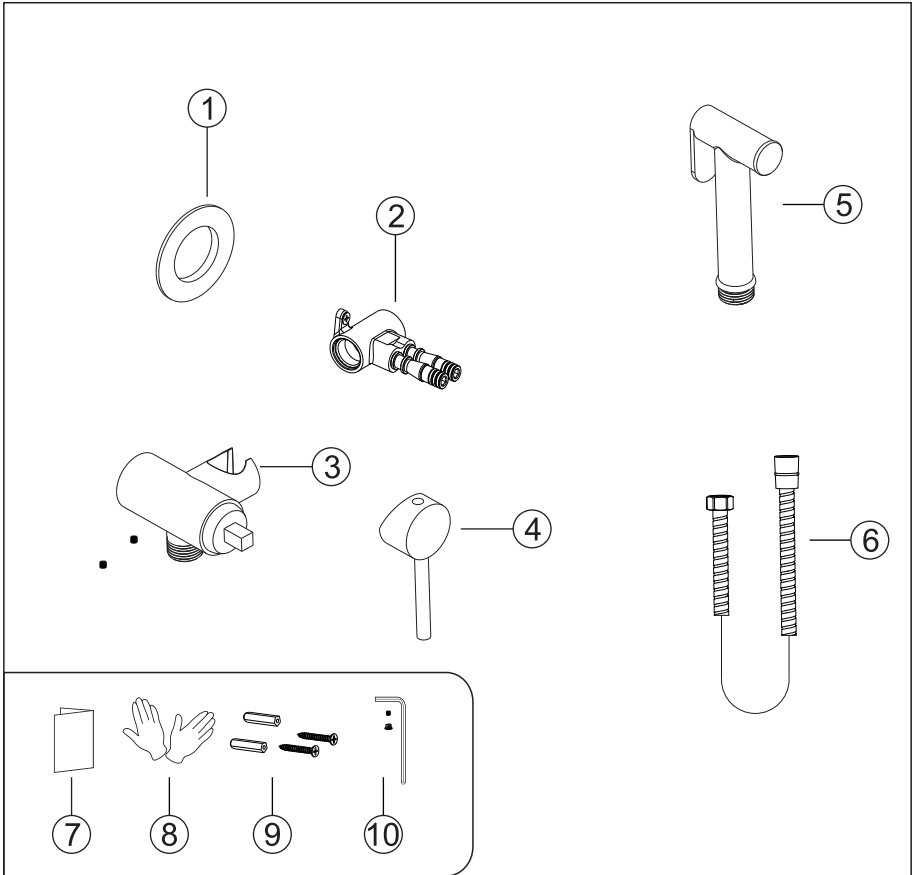

No.	Part name	Qty	No.	Part name	Qty
1	Main body flange	1	6	Shower hose	1
2	Rough-In body	1	7	Instruction manual	1
3	Main body	1	8	Gloves	1pair
4	Handle	1	9	Main body parts	1 set
5	Spray Gun Head	1	10	Handle parts	1 set

◆ Installation Steps

step 1

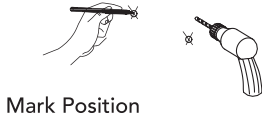

1. Chisel out a 60mm x 60mm recess in the wall for the embedded part, ensuring a depth of 42mm to 50mm including the tile. Then place the concealed unit in the recess, align it properly, and mark the fixing holes on the wall.

2. Align the concealed unit properly and then secure it with screws.

step 2

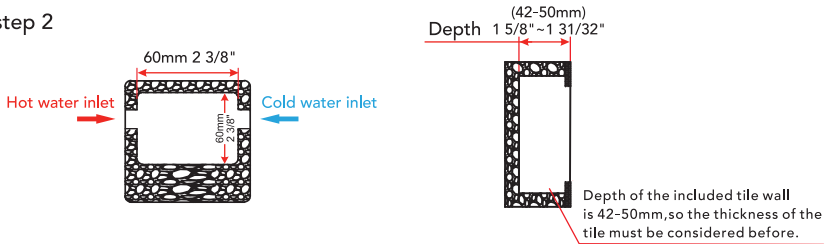

step 3

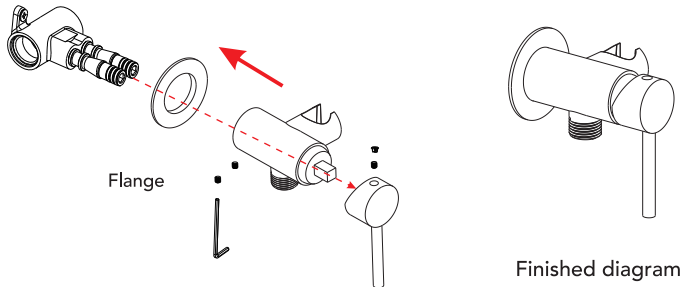

3. Loosen the screws on the main body cover, align the main body with the holes as shown in the diagram, and install it into the main body cover. Then re-tighten the screws to complete the installation of the main body and the main body cover.

◆ Installation of Spray Gun Head and Shower Hose

Model:A

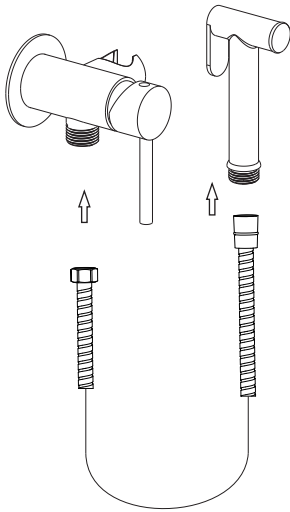

1.Connect the Shower Hose:

Attach one end of the shower hose to the spray gun head, ensuring a firm connection to prevent leaks.

2.Place the Spray Gun Head:

The tail end of the spray gun head can be placed into the shower holder for convenient storage and accessibility.

◆ Instalación y cuestiones de mantenimiento

1. Verifique la lista de accesorios para comprobar que todas las partes están completas en este paquete.
2. No desmonte el cuerpo principal por sí mismo.
3. Conecte las tuberías de entrada a las válvulas de suministro.
4. Asegúrese de que las tuberías de entrada y las válvulas de suministro no tengan impurezas y estén limpias, sin impurezas en la tubería.
5. Después de la instalación, verifique todas las uniones para detectar fugas.
6. No deje el sistema de ducha tipo lluvia expuesto a un ambiente severamente corrosivo.

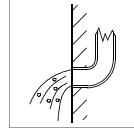
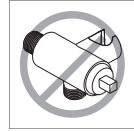

Hacer

1. En para mantener la superficie de la batidora brillante, limpie el mezclador regularmente.
2. Inse el grifo con agua limpia y límpielo con un suave ropa de algodón.
3. Utilice uno de los siguientes limpiadores para eliminar la suciedad de la superficie: a. Limpiador líquido suave. b. Limpiador de vidrio incoloro y limpiador en polvo que no causen abrasión y que se puedan disolver completamente. c. Líquido pulidor que no cause abrasión.

No es decir

- A. Valte con polvo de limpieza, productos químicos de limpieza duros, cepillos y tela gruesa para evitar rasgar y fricción.
- B. No use limpiadores de ácidos para limpiar el grifo, ya que pueden causar corrosión superficial del grifo. Si el grifo está expuesto a sustancias ácidas dañinas, enjuague inmediatamente con agua.

HERRAMIENTAS NECESARIAS:

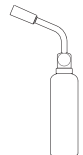
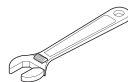
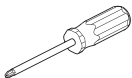

◆ Cuerpo principal del rociador de bidé

Modelo:A

Lista de accesorios

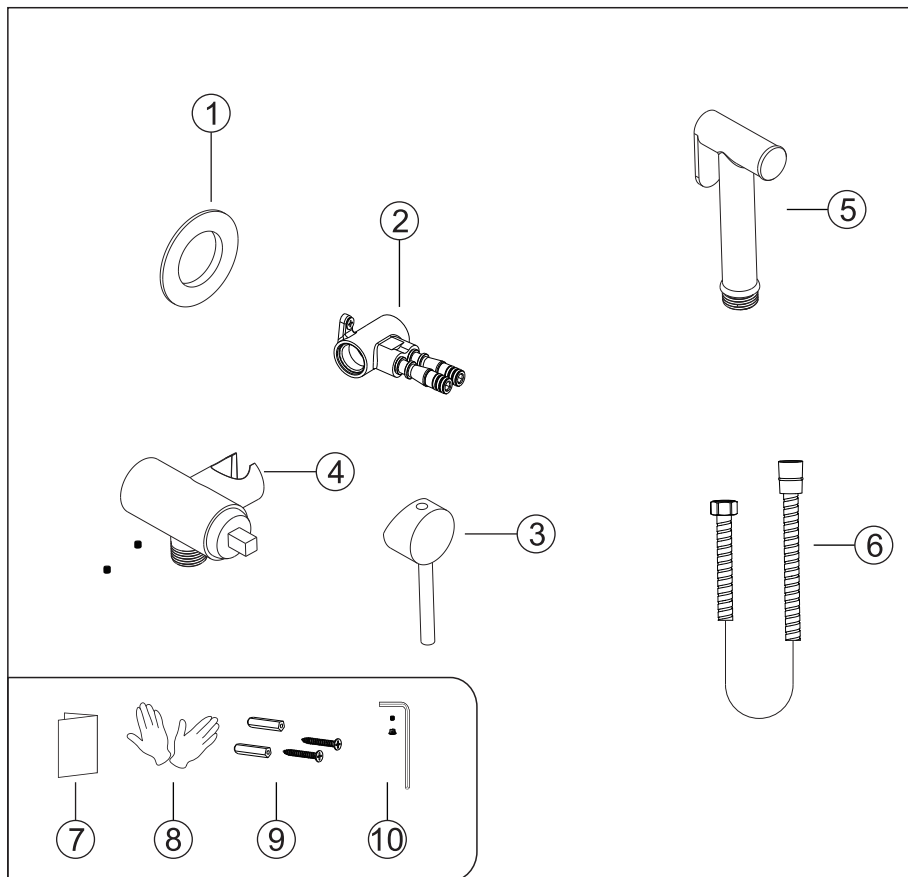

N.º	Nombre de la pieza	Cant.	N.º	Nombre de la pieza	Cant.
1	Brida del cuerpo principal	1	6	Manguera de ducha	1
2	Cuerpo de preinstalación	1	7	Manual de instrucciones	1
3	Cuerpo principal	1	8	Guantes	1 par
4	Manija	1	9	Partes del cuerpo principal	1 juego
5	Cabezal de la pistola rociadora	1	10	Partes de la manija	1 juego

◆ Pasos de instalación

Paso 1



Marcar posición

1. Cincelar un hueco de 60 mm x 60 mm en la pared para la pieza empotrada, asegurando una profundidad de 42 mm a 50 mm incluyendo el azulejo. Luego coloque la unidad oculta en el hueco, alinéelo correctamente y marque los agujeros de fijación en la pared.

2. Alinee correctamente la unidad oculta y luego fíjela con tornillos.

Paso 2

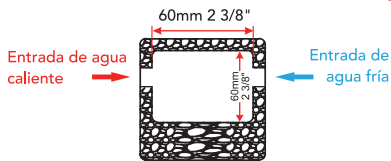

Profundidad $1 \frac{5}{8}'' - 1 \frac{31}{32}''$
(42-50mm)

La profundidad de la pared de azulejos incluida es de 42-50 mm, por lo que el grosor del azulejo debe considerarse previamente.

Paso 3

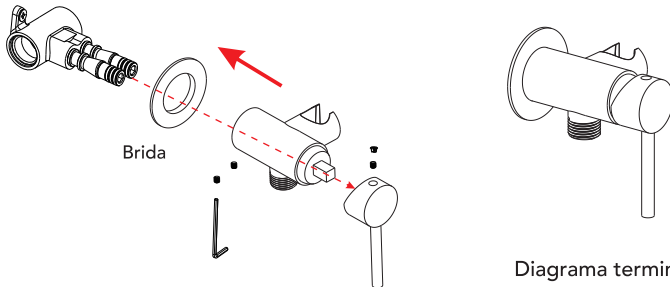

3. Afloje los tornillos de la cubierta del cuerpo principal, alinee el cuerpo principal con los orificios como se muestra en el diagrama y colóquelo dentro de la cubierta del cuerpo principal. Luego, vuelva a apretar los tornillos para completar la instalación del cuerpo principal y la cubierta del cuerpo principal.

◆ Instalación del cabezal de la pistola rociadora y la manguera de ducha

Modelo:A

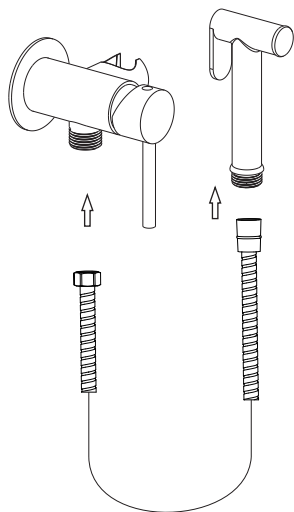

1. Conectar la manguera de ducha:
Conecte un extremo de la manguera de ducha al cabezal de la pistola rociadora, asegurando una conexión firme para evitar fugas.
2. Colocar el cabezal de la pistola rociadora:
El extremo trasero del cabezal de la pistola rociadora puede colocarse en el soporte de ducha para facilitar su almacenamiento y accesibilidad.