

# **Handheld Shower Set Installation Manual**

**W-74(ES)**

# Warranty Duration

All components of this faucet system are covered under a lifetime limited warranty, ensuring they are free from defects in material and workmanship for the original purchaser.

# Repair and Replacement

If the product shows defects in material or workmanship under normal use and within the warranty period, we will, at our discretion, either repair the product or provide a replacement at no cost to the original purchaser. Please note that proof of purchase (e.g., an invoice) is required when requesting service. The warranty does not cover damages caused by improper installation, misuse, or modifications.

# Exclusions

We shall not be responsible for the following cases:

- Damage to the product caused by improper installation, misuse, unauthorized repair or replacement, or abuse (including damage during shipment).
- Damage to the product caused by improper dismantling after installation.
- Damage resulting from abnormal water pressure or impurities in water pipes, which is not covered under this warranty.
- Rust on the product due to insufficient care and maintenance, which is not covered under this warranty.
- Damage caused by natural disasters such as fire, flood, earthquake, lightning storms, etc., which is not covered under this warranty.

I hope this helps! If you have any further questions or concerns, please let me know.

# Having Trouble? Contact us.

✉ Email: [info@faucetsupport.com](mailto:info@faucetsupport.com)

☎ Toll Free: 1-888-969-6880



**M8611**  
**SFS-1129**  
**Model:A**

## **CONTENT**

**1. Installation Instructions for Handheld Shower Set ----- (1-3)**

## **CONTENIDO**

**1. Instrucciones de instalación para el juego de ducha de mano ----- (4-6)**

## ◆ Installation and Maintenance Matters

1. Check the accessories list to verify that all parts are complete in this package.
2. Do not disassemble the main body by yourself.
3. Connect inlet pipes to supply valves.
4. Make sure inlet pipes and supply valves have no impurities and are cleaned, with no impurities in the pipeline.
5. After installation, check all joints for leakages.
6. Do not leave the rain shower system exposed to a severely corrosive environment.

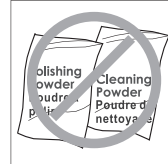
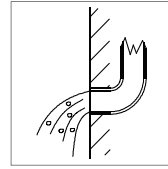

### Do's

1. In order to keep the mixer surface bright, please clean the mixer regularly.
2. Rinse the faucet with clean water and wipe it with a soft cotton cloth.
3. Use one of the following cleaners to remove dirt from the surface: a. Mild liquid cleaner. b. Colorless glass cleaner and powder cleaner that do not cause abrasion and can be dissolved completely. c. Polish liquid that does not cause abrasion.



### Don'ts

- a. Avoid using cleaning powder, harsh cleaning chemicals, brushes and coarse cloth to prevent scratching and friction.
- b. Do not use acid cleaners to clean the faucet as they may cause surface corrosion of the faucet. If the faucet is exposed to harmful acid substances, please rinse it immediately with water.

### Tools Needed:

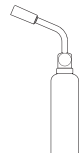
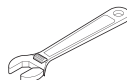
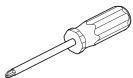

◆ **Handheld Shower Set**  
**Model:A**  
**Accessories List**

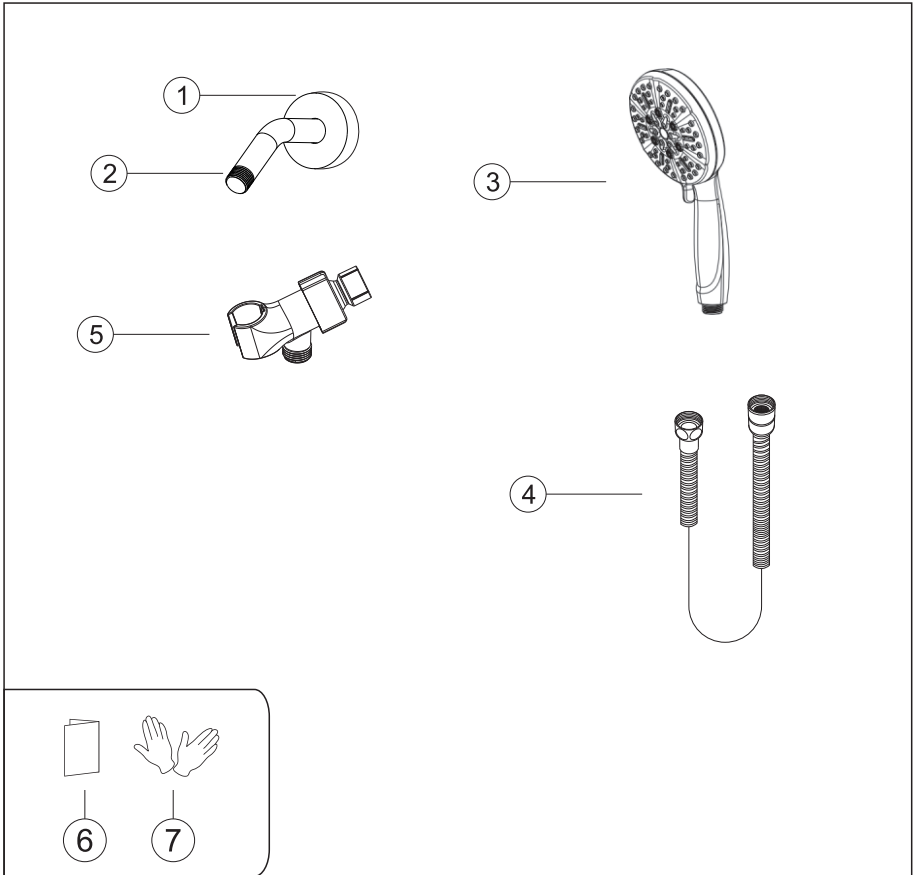

No.	Part name	Qty	No.	Part name	Qty
1	Shower arm flange	1	5	Hand shower holder	1
2	Shower arm	1	6	Instruction manual	1
3	Hand shower	1	7	Gloves	1
4	Shower hose	1	8		1

## ◆ The Installation Depth of Shower Arm

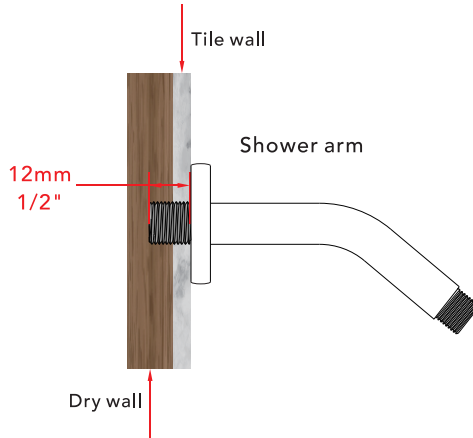

The thickness of the tile must be calculated for installation.

Connector size of male thread: USA: 1/2"-14NPT, Canada: 1/2"-14NPT, Europe: G1/2".

## ◆ Installation of the Shower Arm and Hand Shower Holder

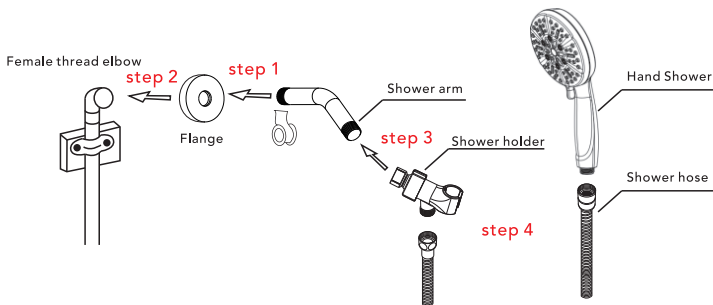

Step1.As shown in the diagram, attach the flange to the shower arm and wrap sealing tape around one end.

Step2.As illustrated, screw the shower holder (with the sealing tape applied) securely into the water supply pipe in the wall until it is tight and leak-free.

Step3.Connect one end of the shower holder to the other end of the shower arm, as shown in the illustration, and tighten it securely.

Step4.Refer to the diagram to connect the shower hose to both the hand shower and the shower holder. Tighten the hose fittings until no leaks are detected.

## ◆ Instalación y cuestiones de mantenimiento

1. Verifique la lista de accesorios para comprobar que todas las partes están completas en este paquete.
2. No desmonte el cuerpo principal por sí mismo.
3. Conecte las tuberías de entrada a las válvulas de suministro.
4. Asegúrese de que las tuberías de entrada y las válvulas de suministro no tengan impurezas y estén limpias, sin impurezas en la tubería.
5. Después de la instalación, verifique todas las uniones para detectar fugas.
6. No deje el sistema de ducha tipo lluvia expuesto a un ambiente severamente corrosivo.

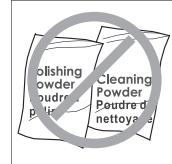
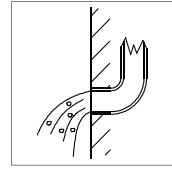

Hacer

1. En para mantener la superficie de la batidora brillante, limpie el mezclador regularmente.
2. Inse el grifo con agua limpia y límpielo con un suave ropa de algodón.
3. Utilice uno de los siguientes limpiadores para eliminar la suciedad de la superficie: a. Limpiador líquido suave. b. Limpiador de vidrio incoloro y limpiador en polvo que no causen abrasión y que se puedan disolver completamente. c. Líquido pulidor que no cause abrasión.

No es decir

- A. Valte con polvo de limpieza, productos químicos de limpieza duros, cepillos y tela gruesa para evitar rascar y fricción.
- B. No use limpiadores de ácidos para limpiar el grifo, ya que pueden causar corrosión superficial del grifo. Si el grifo está expuesto a sustancias ácidas dañinas, enjuague inmediatamente con agua.

### HERRAMIENTAS NECESARIAS:

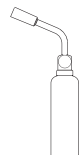
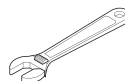
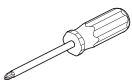

◆ **Juego de ducha de mano**

**Modelo:A**

**Lista de accesorios**

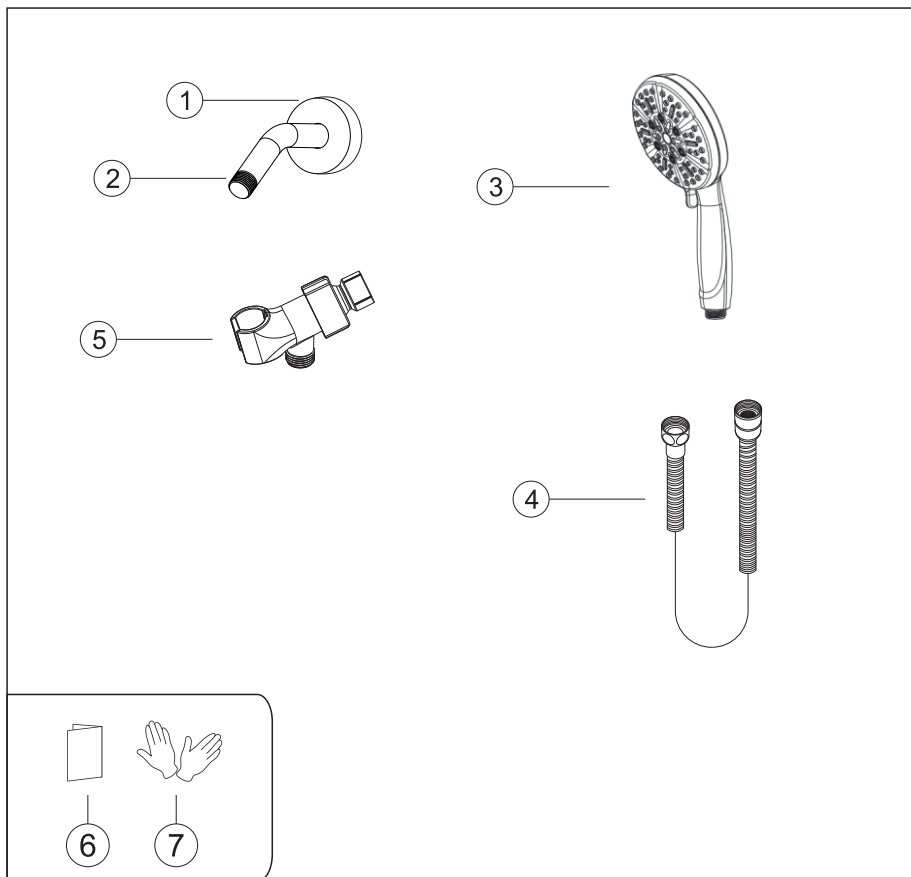

N.º	Nombre de la pieza	Cant	N.º	Nombre de la pieza	Cant
1	Brida del brazo de ducha	1	5	Soporte para ducha de mano	1
2	Brazo de ducha	1	6	Manual de instrucciones	1
3	Ducha de mano	1	7	Guantes	1
4	Manguera de ducha	1	8		1

## ◆ La profundidad de instalación del brazo de ducha

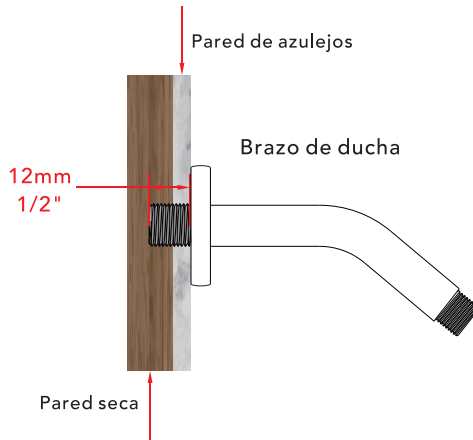

El grosor del azulejo debe calcularse para la instalación. Tamaño del conector de rosca macho: EE.UU.: 1/2"-14NPT Canadá: 1/2"-14NPT Europa: G1/2".

## ◆ Instalación del brazo de ducha y del soporte para ducha de mano

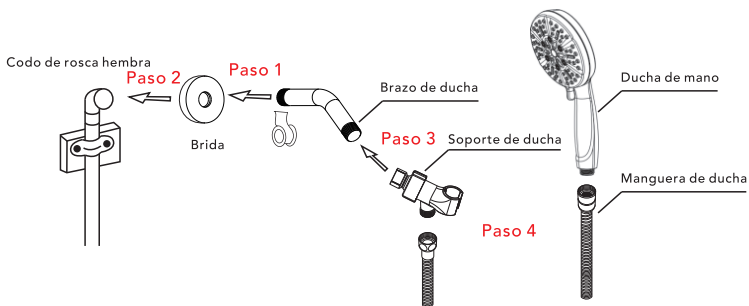

- Paso 1. Como se muestra en el diagrama, coloque la brida en el brazo de ducha y envuelva cinta de sellado alrededor de un extremo.
- Paso 2. Como se muestra en la ilustración, atornille el soporte de ducha (con cinta de sellado previamente envuelta) en la tubería de agua de la pared hasta que quede ajustado y sin fugas.
- Paso 3. Como se muestra en la ilustración, conecte un extremo del soporte de ducha al otro extremo del brazo de ducha y ajústelo bien.
- Paso 4. Como se muestra en el diagrama, conecte la manguera de ducha a la ducha de mano y al soporte de ducha, y ajuste las conexiones de la manguera de ducha hasta que no haya fugas.