

Kitchen Faucet Installation Manual

W-206(ES)

Warranty Duration

All components of this faucet system are covered under a lifetime limited warranty, ensuring they are free from defects in material and workmanship for the original purchaser.

Repair and Replacement

If the product shows defects in material or workmanship under normal use and within the warranty period, we will, at our discretion, either repair the product or provide a replacement at no cost to the original purchaser. Please note that proof of purchase (e.g., an invoice) is required when requesting service. The warranty does not cover damages caused by improper installation, misuse, or modifications.

Exclusions

We shall not be responsible for the following cases:

- Damage to the product caused by improper installation, misuse, unauthorized repair or replacement, or abuse (including damage during shipment).
- Damage to the product caused by improper dismantling after installation.
- Damage resulting from abnormal water pressure or impurities in water pipes, which is not covered under this warranty.
- Rust on the product due to insufficient care and maintenance, which is not covered under this warranty.
- Damage caused by natural disasters such as fire, flood, earthquake, lightning storms, etc., which is not covered under this warranty.

I hope this helps! If you have any further questions or concerns, please let me know.

Having Trouble? Contact us.

✉ Email: info@faucetsupport.com

☎ Toll Free: 1-888-969-6880

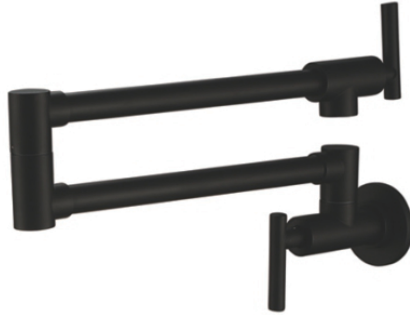

**SFS-1088
M3805**

◆ **Important Considerations for Installing a Kitchen Faucet**

1. Check Accessories

Before installation, carefully inspect the package to ensure all accessories are included and undamaged.

Refer to the accessory list in the installation manual to verify that every component is accounted for.

2. Turn off Water Supply

Before beginning installation, make sure to shut off both the hot and cold water supply valves under the kitchen sink to prevent any potential water leakage.

3. Prepare Tools

Common necessary tools include: an adjustable wrench, screwdriver, Teflon tape (plumber's tape), sealant, and other basic plumbing tools as needed.

4. Check for Leaks

After turning the water supply back on, test the faucet to ensure it operates correctly.

Inspect all connections for any signs of leakage. If any leaks are detected, tighten fittings or replace sealing materials as needed.

5. Cleaning and Maintenance

Once installation is complete, clean the faucet and surrounding area to remove any remaining debris or installation residue.

Regularly inspect the faucet connections and surfaces to maintain cleanliness and ensure proper long-term function.

◆ **List of Kitchen Faucet Accessories**

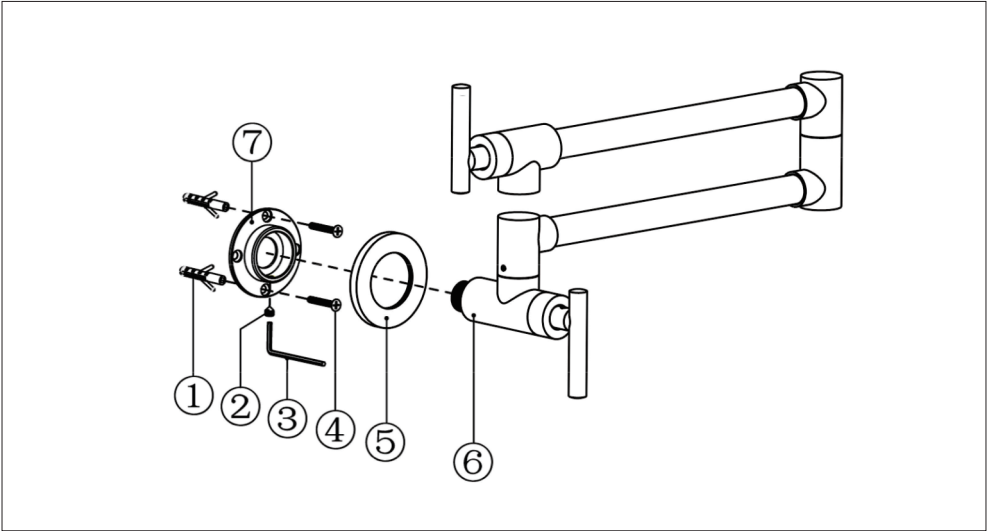

No.	Part Name	Qty
1	Plastic wall plug	1 set
2	Hex socket screw	1
3	Hex key	1
4	Self-tapping screw	1 set
5	Decorative cover	1
6	Tap body	1
7	Fixed base	1

TOOLS NEEDED:

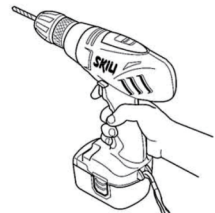
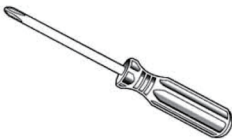

◆ Installation Steps

Step1

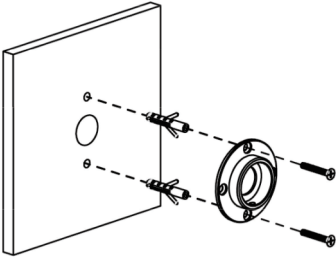

Select an appropriate location for drilling, and use a drill and screwdriver to secure the base to the wall.
Take care not to damage any pipes hidden behind the wall during drilling.

Step2

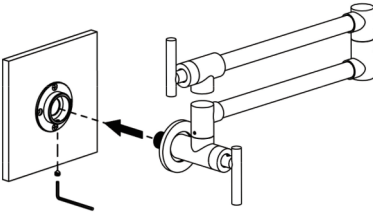

Wrap PTFE tape around the adapter. Screw the tap body into the correct position, then tighten the hex socket screws using a hex key (Allen wrench).

Step3

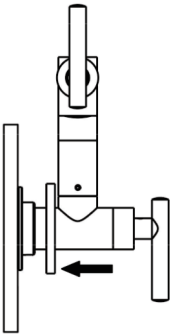

Turn on the tap to allow water to flow and check for any leaks.
Finally, firmly press the decorative cover against the wall.

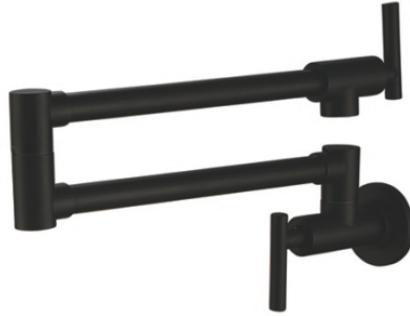

SFS-1088
M3805

◆ **Consideraciones Importantes para la Instalación de un Grifo de Cocina**

1. Revisar los Accesorios

Antes de la instalación, revise cuidadosamente si todos los accesorios del paquete están completos y sin daños. Compare con la lista de accesorios en el manual de instalación para asegurarse de que cada pieza esté presente.

2. Cerrar el Suministro de Agua

Antes de comenzar la instalación, asegúrese de cerrar las válvulas de suministro de agua caliente y fría en el área de la cocina para evitar cualquier incidente de fuga de agua.

3. Preparar Herramientas

Las herramientas necesarias comunes incluyen: llave inglesa, destornillador, cinta de teflón, sellador, etc.

4. Verificar Fugas

Abra las válvulas de suministro de agua, pruebe si el grifo funciona correctamente y revise todas las conexiones en busca de signos de fugas. Si se encuentran fugas, ajuste o reemplace los materiales de sellado según sea necesario.

5. Limpieza y Mantenimiento

Después de la instalación, limpie el grifo y el área circundante para eliminar cualquier material sobrante de la instalación. Revise regularmente las conexiones del grifo para mantenerlo limpio y en buen estado.

◆ Lista de Accesorios para Grifo de Cocina

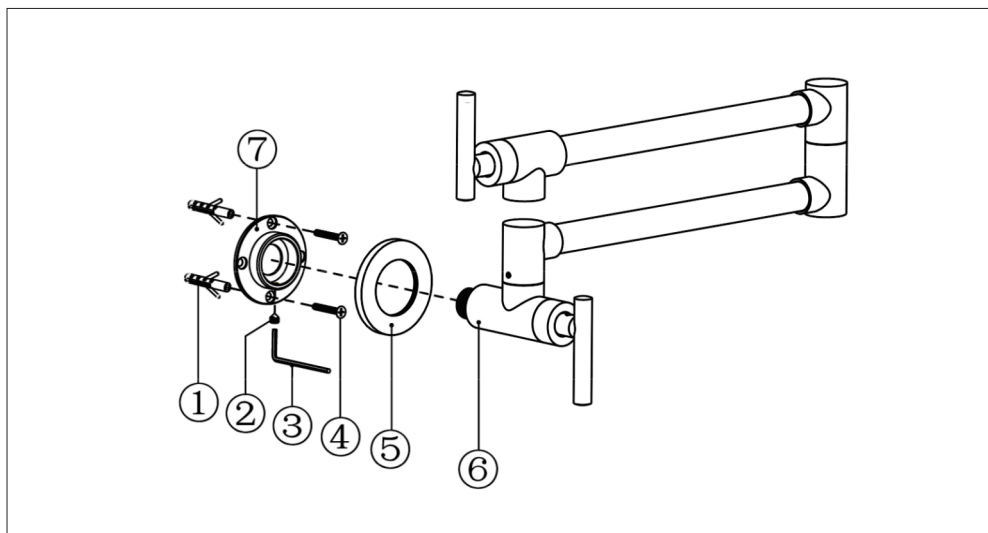

N.º	Nombre de la Pieza	Cant.
1	Taco de Plástico	1 juego
2	Tornillo de Cabeza Hexagonal	1
3	Llave Allen	1
4	Tornillo Aut roscante	1 juego
5	Cubierta Decorativa	1
6	Cuerpo del Grifo	1
7	Base Fija	1

HERRAMIENTAS NECESARIAS:

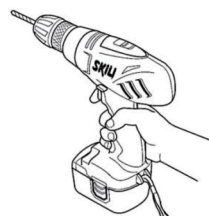
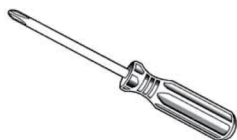

◆ Pasos de instalación

Paso 1

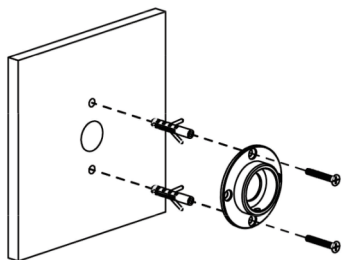

Elija la ubicación adecuada para taladrar y fijar la base en la pared con un taladro y un destornillador. Tenga cuidado de no dañar las tuberías en la pared al perforar.

Paso 2

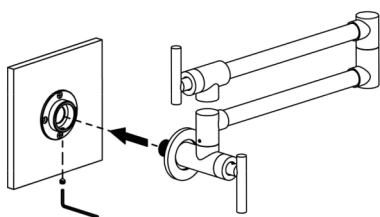

Envuelva la cinta de PTFE en el adaptador, atornille el cuerpo del grifo a la posición adecuada y luego ajuste los tornillos de cabeza hexagonal con una llave Allen.

Paso 3

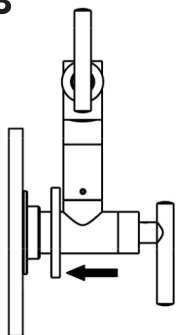

Abra el grifo para que fluya el agua y verifique si hay alguna fuga. Finalmente, presione la cubierta decorativa firmemente contra la pared.