

Thermostatic Shower Faucet Installation Manual

W-253(ES)

Warranty Duration

All components of this faucet system are covered under a lifetime limited warranty, ensuring they are free from defects in material and workmanship for the original purchaser.

Repair and Replacement

If the product shows defects in material or workmanship under normal use and within the warranty period, we will, at our discretion, either repair the product or provide a replacement at no cost to the original purchaser. Please note that proof of purchase (e.g., an invoice) is required when requesting service. The warranty does not cover damages caused by improper installation, misuse, or modifications.

Exclusions

We shall not be responsible for the following cases:

- Damage to the product caused by improper installation, misuse, unauthorized repair or replacement, or abuse (including damage during shipment).
- Damage to the product caused by improper dismantling after installation.
- Damage resulting from abnormal water pressure or impurities in water pipes, which is not covered under this warranty.
- Rust on the product due to insufficient care and maintenance, which is not covered under this warranty.
- Damage caused by natural disasters such as fire, flood, earthquake, lightning storms, etc., which is not covered under this warranty.

I hope this helps! If you have any further questions or concerns, please let me know.

Having Trouble? Contact us.

✉ Email: info@faucetsupport.com

☎ Toll Free: 1-888-969-6880



CEC **FC** **C** **€** **RoHS**



M6509
SFS-1061

CONTENT

Thermostatic Shower Faucet Installation Manual ----- (1-6)

CONTENIDO

Manual de Instalación del Grifo de Ducha Termostático ----- (7-12)

◆ Installation and Maintenance Instructions

1. Check the accessories list to verify that all parts are complete in this package.
2. Do not disassemble the main body by yourself.
3. Connect inlet pipes to supply valves.
4. Make sure inlet pipes and supply valves have no impurities and are cleaned, with no impurities in the pipeline.
5. After installation, check all joints for leakages.
6. Do not leave the rain shower system exposed to a severely corrosive environment.

Do's

1. In order to keep the mixer surface bright, please clean the mixer regularly.
2. Rinse the faucet with clean water and wipe it with a soft cotton cloth.
3. Use one of the following cleaners to remove dirt from the surface:
 - a. Mild liquid cleaner.
 - b. Colorless glass cleaner and powder cleaner that do not cause abrasion and can be dissolved completely.
 - c. Polish liquid that does not cause abrasion.

Don'ts

1. Avoid using cleaning powder, harsh cleaning chemicals, brushes and coarse cloth to prevent scratching and friction.
2. Do not use acid cleaners to clean the faucet as they may cause surface corrosion of the faucet. If the faucet is exposed to harmful acid substances, please rinse it immediately with water.

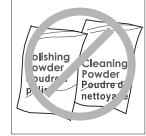
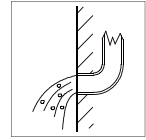
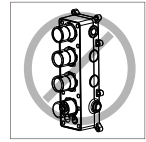

Tools Needed:

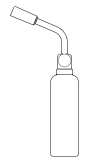
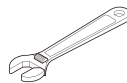
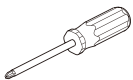

◆ 3-Function Rain Shower Faucet Accessories List

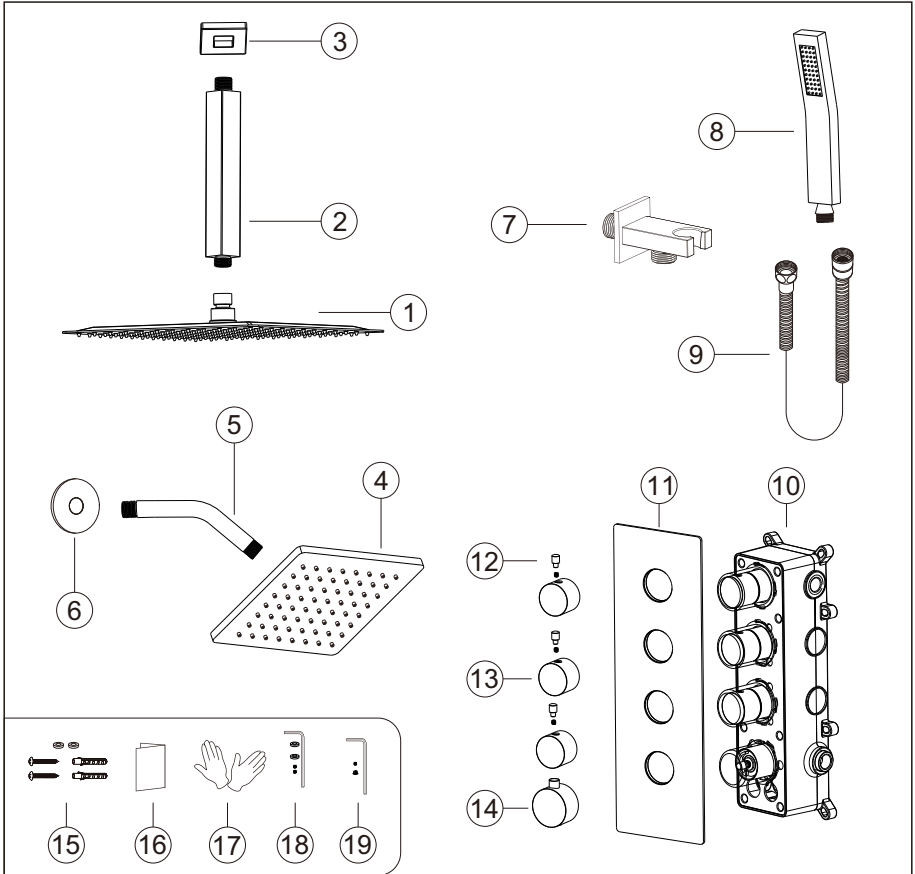

No.	Part name	Qty	No.	Part name	Qty
1	Shower head	1	11	Deck plate	1
2	Shower arm	1	12	Water diverter rod	3
3	Shower arm cover	1	13	Water diverter	3
4	6in Shower head	1	14	Handle	1
5	Shower arm	1	15	Main body spare parts	8
6	Shower arm cover	1	16	Instruction manual	1
7	Hand shower holder	1	17	Gloves	2
8	Hand shower	1	18	Shower holder parts	1 set
9	Shower hose	1	19	Handle parts	1 set
10	Main body	1			

◆ Essential Dimensions & Water Pipe Lines

Unit: mm/inch

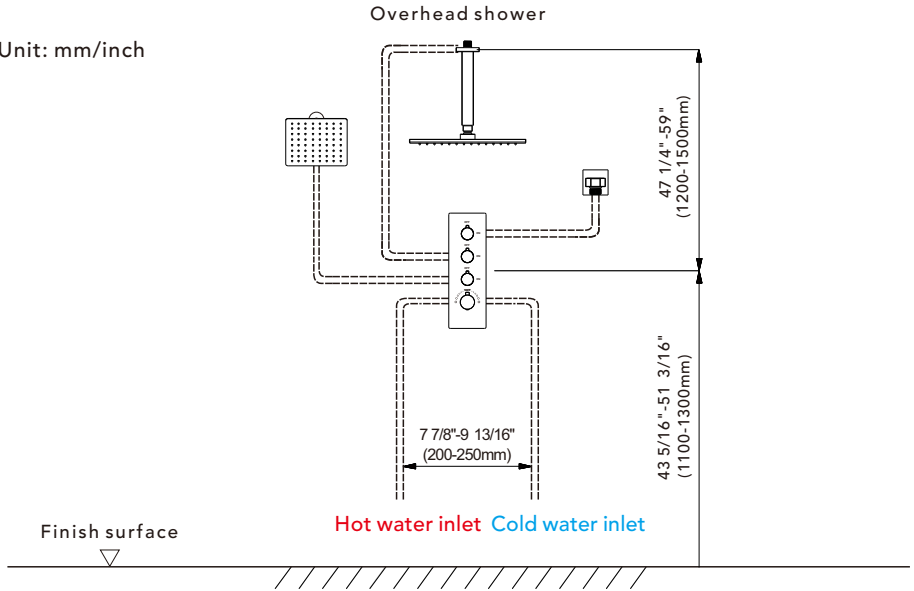

◆ Installation Depth of the Shower Arm and Hand Shower Holder

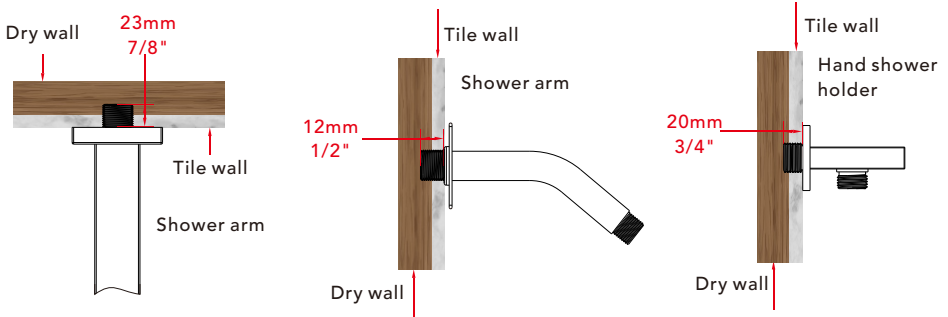

The thickness of the tile must be calculated for installation.

Connector size of male thread: USA: 1/2"-14NPT, Canada: 1/2"-14NPT, Europe: G1/2".

◆ Installation Depth of the Main Body

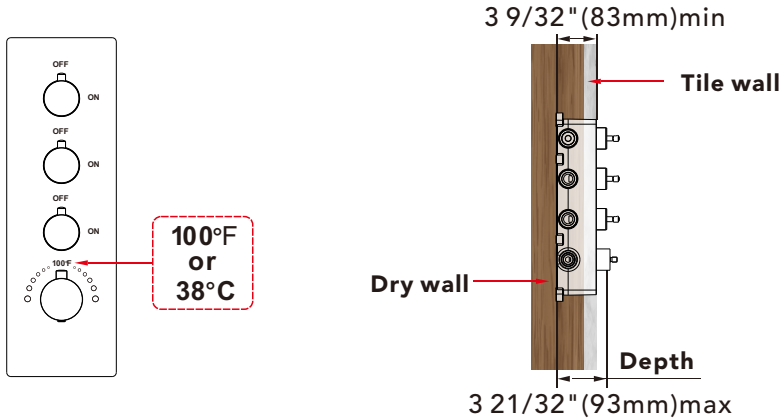

- Notice: 1. The installation depth of the main body should be no less than $3 \frac{9}{32}$ " (83mm) and no more than $3 \frac{21}{32}$ " (93mm), including the thickness of the tile. Otherwise, the deck plate cannot be installed.
2. The opening size of ceramic tile shall be smaller than the deck plate size.

◆ Piping Instructions before Tiling

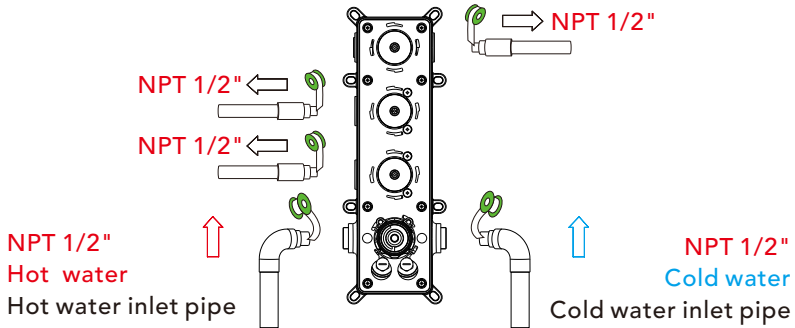

1. As shown in the figure, the inlet and outlet pipes are pre-buried. Please pay attention to the correct direction when installing the pre-buried main body.
2. Before tiling, turn on the water to test whether the left and right inlet pipes are tightly connected without leakage. Then, adjust the flow switch to the "on" position to check for leaks in the mixed outlet pipes.

◆ Main Body Valve Installation

Step1

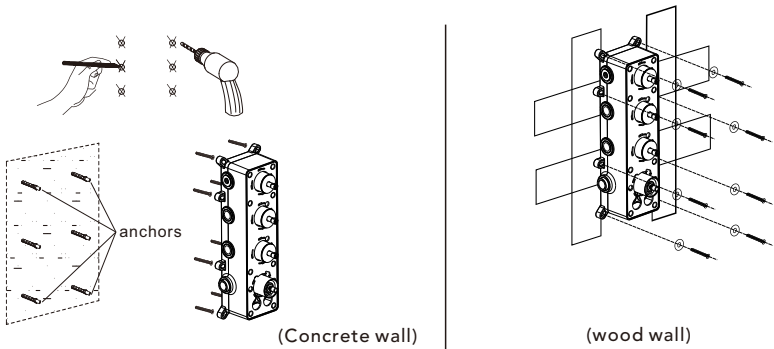

1. Make marks according to the dimensions of the main body valve, then drill anchors into the wall (for a concrete wall).
 2. Secure the main body directly to a wood wall using screws.
 3. When installing the main body, ensure the "UP" side is facing upwards; do not install it upside down.
- ▲ Please note: The level meter should be parallel to the wall; otherwise, the deck plate cannot be installed properly.

Step2

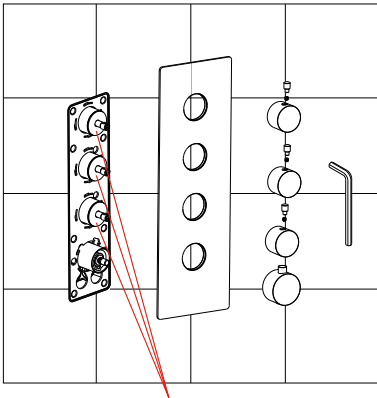

Do not remove the white wear ring; otherwise, the handwheel will be damaged.

Precautions for Handwheel Installation

- ※1. The line can't be misplaced; it should be kept in line. Otherwise, the water temperature of 100°F or 38°C will not be correct.



- ※2. Please ensure that the plastic locating ring (A) and handwheel locating pin (B) are kept in the same line with 100°F or 38°C. Otherwise, the water temperature will be incorrect.

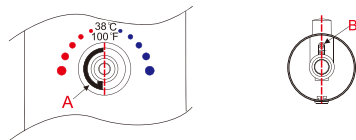

1. Please install the deck plate, water diverters, and water diverter rods step by step.
2. Install the handle using the screw provided, and then secure it with the handle cap.

◆ Hand Shower Holder Installation

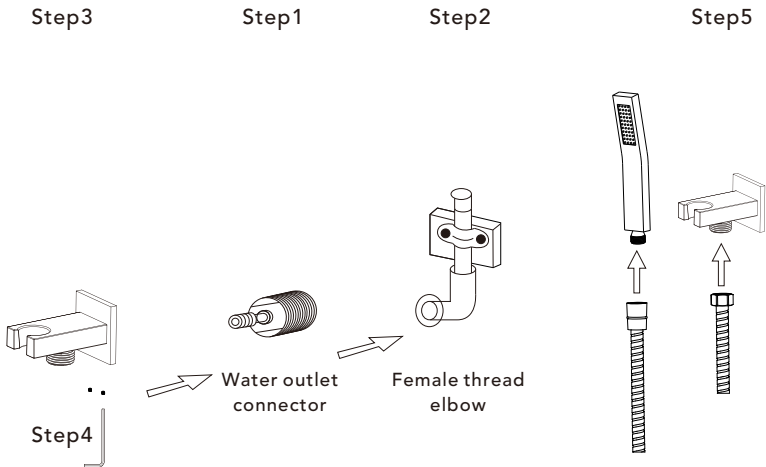

Step1.Remove the male connector from the top of the shower holder (do not damage the gasket, otherwise it will leak).

Step2.Screw the thread into the water pipe inside the wall

Step3.Screw the main body into the thread.

Step4.Rotate and fix the body with the special-shaped wrench

Step5.Connect hand shower and the hose.

◆ Shower Head Installation

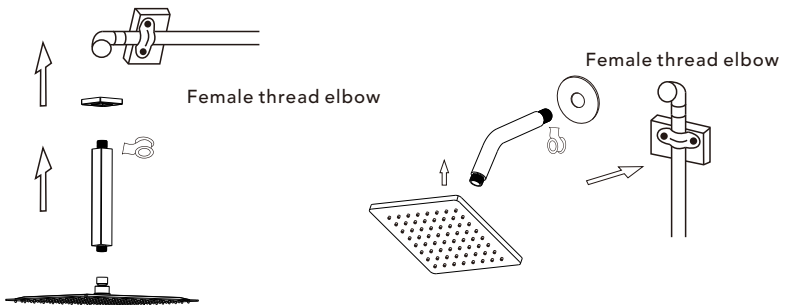

1.Connect shower arm with the cover before screwing arm into riser connection to prevent damage.

2.Fix shower head onto shower arm and apply tape to pipe threads on both ends.

3.Do not over tighten shower head. It is 360° swivel connection.

◆ Instalación y Cuestiones de Mantenimiento

1. Compruebe la lista de accesorios para verificar que todas las piezas están completas en este paquete.
2. No desmonte el cuerpo principal por su cuenta.
3. Conecte las tuberías de entrada a las válvulas de suministro.
4. Asegúrese de que las tuberías de entrada y las válvulas de suministro no tengan impurezas y estén limpias, y de que no haya impurezas en la tubería.
5. Después de la instalación, compruebe que todas las uniones no presenten fugas.
6. No deje el sistema de ducha tipo lluvia expuesto a un entorno altamente corrosivo.

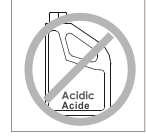
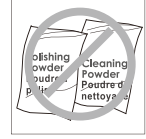
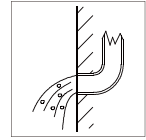
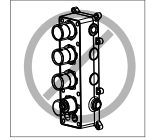

Qué Sí Hacer

1. Para mantener brillante la superficie del grifo, límpielo regularmente.
2. Enjuague el grifo con agua limpia y séquelo con un paño de algodón suave.
3. Utilice uno de los siguientes limpiadores para eliminar la suciedad de la superficie:
 - a. Limpiador líquido suave.
 - b. Limpiador de vidrio incoloro y limpiador en polvo que no causen abrasión y se disuelvan completamente.
 - c. Líquido de pulido que no cause abrasión.

Qué No Hacer

1. Evite el uso de polvos de limpieza, productos químicos de limpieza agresivos, cepillos y trapos ásperos para evitar arañazos y rozaduras.
2. No utilice limpiadores ácidos para limpiar el grifo, ya que pueden causar corrosión en la superficie. Si el grifo entra en contacto con sustancias ácidas dañinas, enjuáguelo inmediatamente con agua.

Herramientas Necesarias:

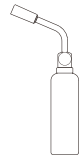
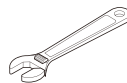
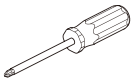

◆ Grifo de Ducha de Lluvia de 3 Funciones

Lista de Accesorios

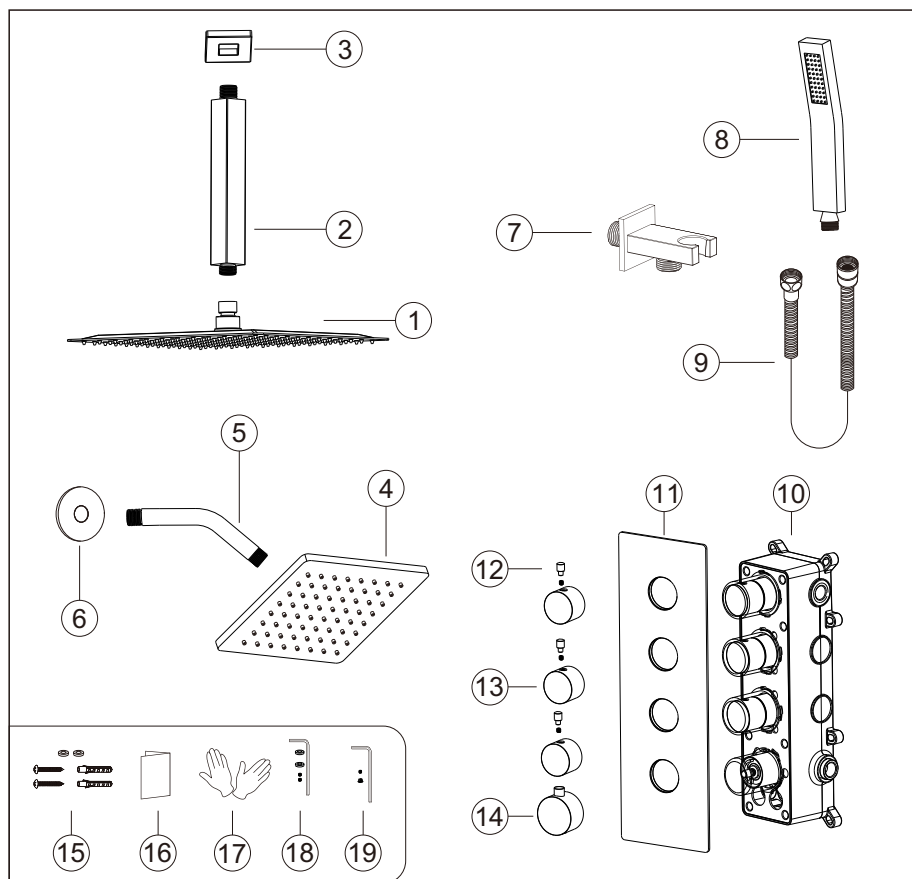

N.º	Nombre de la pieza	Cantidad	N.º	Nombre de la pieza	Cantidad
1	Cabezal de ducha	1	11	Placa de cubierta	1
2	Brazo de ducha	1	12	Varilla desviadora de agua	3
3	Cubierta de brazo de ducha	1	13	Desviador de agua	3
4	Cabezal de ducha de 6 pulgadas	1	14	Manija	1
5	Brazo de ducha	1	15	Piezas de repuesto del cuerpo principal	8
6	Cubierta de brazo de ducha	1	16	Manual de instrucciones	1
7	Soporte para ducha de mano	1	17	Guantes	2
8	Ducha de mano	1	18	Piezas del soporte de ducha	1 juego
9	Manguera de ducha	1	19	Piezas de la manija	1 juego
10	Cuerpo principal	1			

◆ Dimensiones Esenciales y Líneas de Tubería de Agua

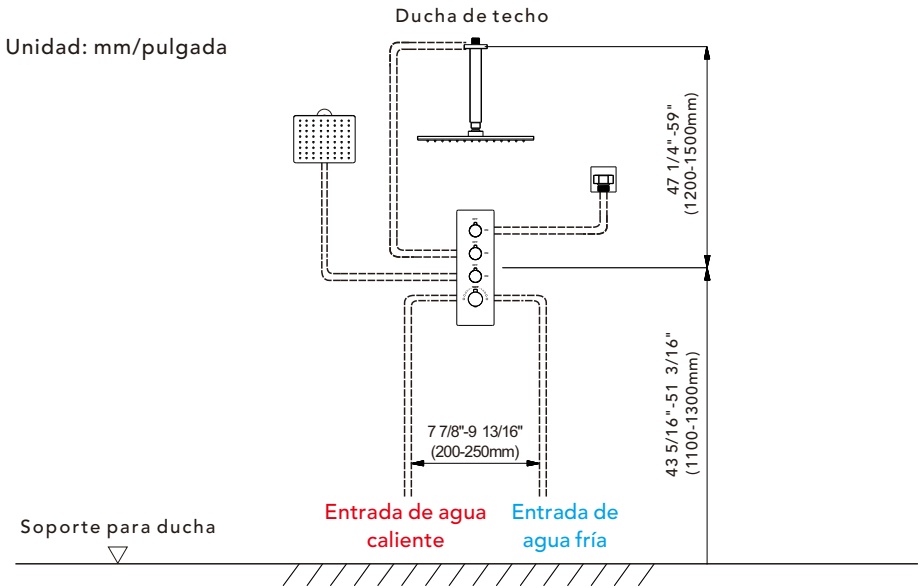

◆ Profundidad de Instalación del Brazo de Ducha y Soporte de Ducha

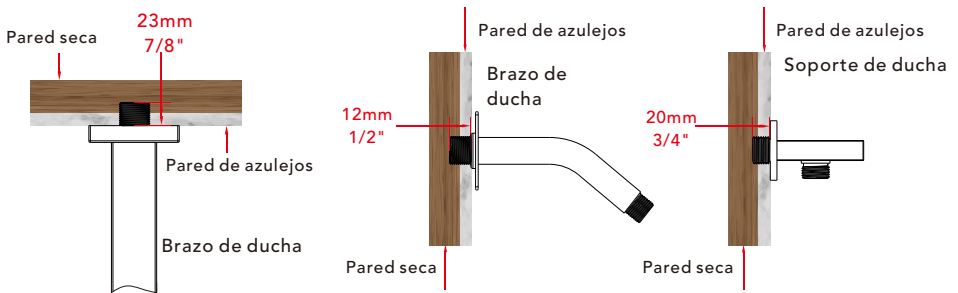

El grosor del azulejo debe ser calculado para la instalación.

Tamaño del conector de rosca macho: EE. UU.: 1/2"-14NPT, Canadá: 1/2"-14NPT, Europa: G1/2".

◆ Profundidad de Instalación del Cuerpo Principal

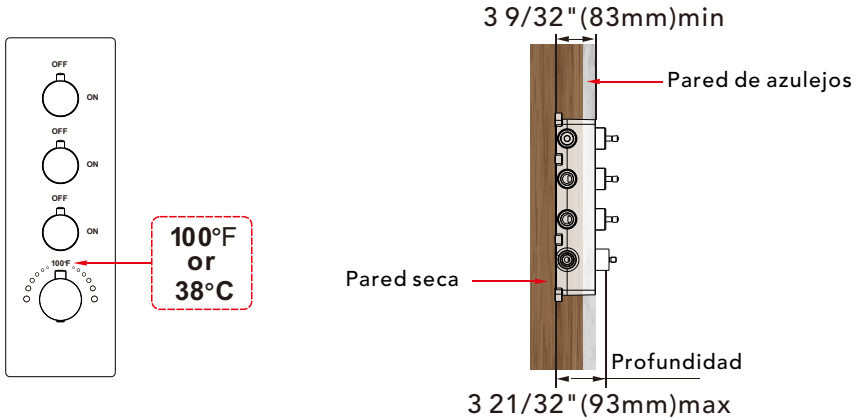

- Aviso: 1. La profundidad de instalación del cuerpo principal no debe ser inferior a 3 9/32" (83 mm) y no más de 3 21/32" (93 mm), incluyendo el grosor del azulejo. De lo contrario, la placa de cubierta no podrá ser instalada.
2. El tamaño de apertura del azulejo cerámico debe ser menor que el tamaño de la placa de cubierta.

◆ Instrucciones de Tuberías antes del Alicatado

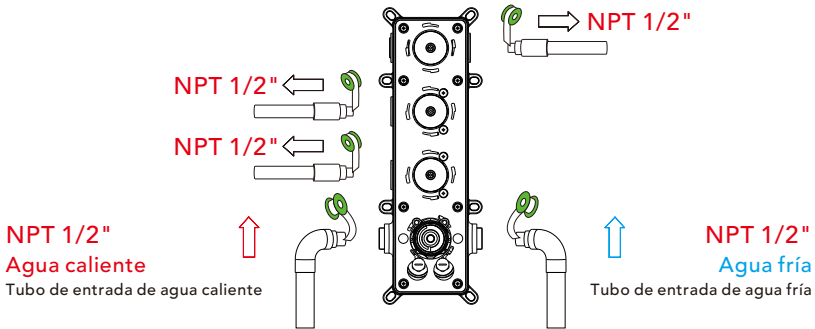

1. Como se muestra en la figura, las tuberías de entrada y salida están pre-enterradas. Por favor, preste atención a la dirección correcta al instalar el cuerpo principal pre-enterrado.
2. Antes de colocar los azulejos, abra el agua para probar si las tuberías de entrada izquierda y derecha están conectadas herméticamente sin fugas. Luego, ajuste el interruptor de flujo a la posición "on" para comprobar si hay fugas en las tuberías de salida mezcladas.

◆ Instalación de la Válvula del Cuerpo Principal

Paso1

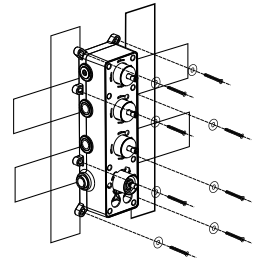
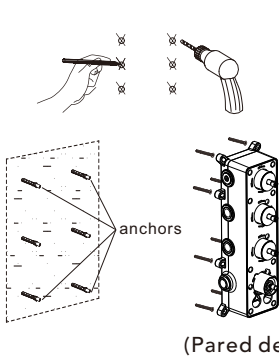

(pared de madera)

1. Marque según el tamaño de la válvula del cuerpo principal y luego perforo para colocar los anclajes en la pared (pared de concreto).
2. Fije directamente el cuerpo principal a la madera con tornillos (pared de madera).
3. Al instalar el cuerpo principal, por favor marque el lado UP hacia arriba y no lo instale al revés.

▲ Tenga en cuenta que el nivel debe estar paralelo a la pared; de lo contrario, la placa de cubierta no podrá ser instalada.

Paso2

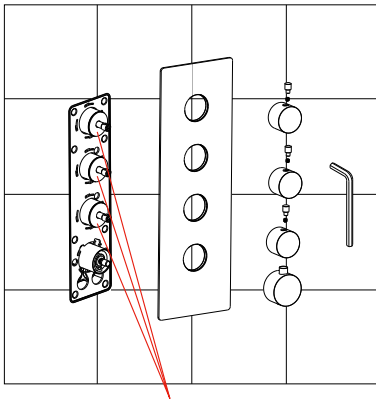

No quite el anillo de desgaste blanco; de lo contrario, el volante se dañará

Precauciones para la Instalación del Volante

- ※1. La línea no puede estar mal colocada; debe mantenerse alineada. De lo contrario, la temperatura del agua de 100°F o 38°C no será correcta.

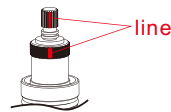

- ※2. Por favor, asegúrese de que el anillo localizador de plástico (A) y el pasador localizador del volante (B) se mantengan en la misma línea con 100°F o 38°C. De lo contrario, la temperatura del agua será incorrecta.

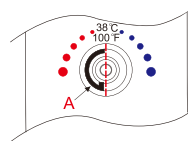

1. Por favor, instale la placa de cubierta, los desviadores de agua y las varillas desviadoras de agua paso a paso.
2. Instale la manija con el tornillo y la tapa de la manija.

◆ Instalación del Soporte de Ducha de Mano

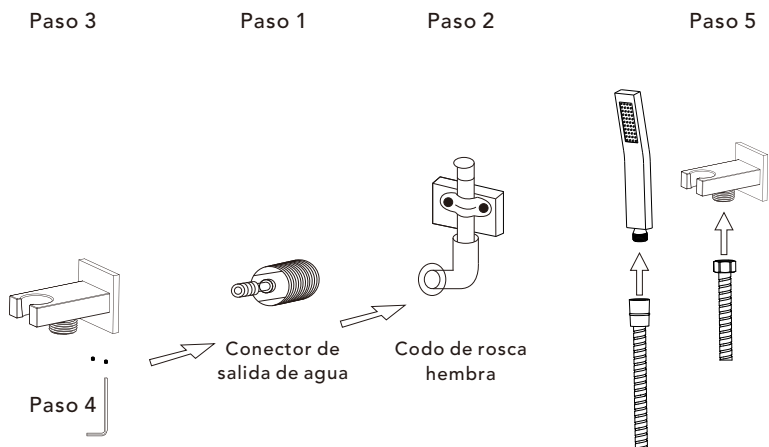

Paso 1. Retire el conector macho de la parte superior del soporte de la ducha (no dañe la junta, de lo contrario, habrá fugas).

Paso 2. Enrosque la rosca en la tubería de agua dentro de la pared

Paso 3. Enrosque el cuerpo principal en la rosca.

Paso 4. Rote y fije el cuerpo con la llave especial.

Paso 5. Conecte la ducha manual y la manguera.

◆ Instalación del Cabezal de Ducha

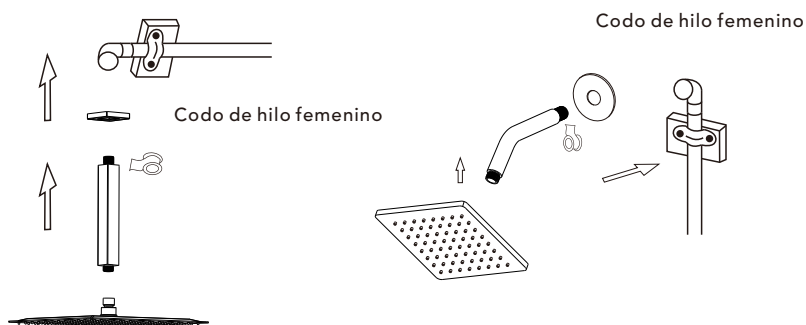

1. Conecte el brazo de la ducha con la cubierta antes de atornillar el brazo en la conexión del elevador con prevenir el daño.

2. Fije el cabezal de la ducha en el brazo de la ducha y aplique cinta adhesiva para las roscas de tubos en ambos extremos.

3. No revolotee la cabeza de ducha. Es una conexión giratoria de 360°.